

Introduction

TD-ISRM RS RF PERFORMANCE

With solid performance based on the dual-band 900M/2.4G RF signal link with multiple operating combinations of RF modes, the TANDEM X20R & X20RS versions are equipped with the TD-ISRM RS built-in RF module which is capable of supporting multiple protocols (like TW, TD, etc).

The TD-ISRM RS RF module has the dual 2.4G TW RF mode and supports simultaneous activation of working under TW and ACCESS R9 modes with the same module. In this configuration, the TW receiver and ACCESS R9 receiver can be connected via the SBUS IN/OUT ports to achieve redundant backup. This RF signal connection solution makes use of three different RF links at the same time in RC applications. This further enhances the RF signal's reliability, particularly in long-distance RC operations scenarios.

DIFFERENCES IN APPEARANCE & FUNCTIONAL INPUTS

The X20R and X20RS have changed from the original X20 design in appearance. The bottom hand grip adopts the overall design of the PRO version, eliminating the need for an additional grip cover, and allowing the bottom part to be fully grasped by the palm for a more comfortable and relaxed grip. Additionally, the Lite-type external module slot has been adjusted to provide more fitting installation space for external modules of different shapes, making it more convenient.

R and RS versions add 2 extra trims, allowing for more precise tunings during the operations. The slider levers on both sides of the transmitter support adjusting the positioning of the center, catering to different users' habits and preferences. The primary input components, including trim caps, center-slider caps, and knobs are all made from metal, offering rugged quality and enhanced durability for outdoor use.

UPGRADED ROBUST ANTENNA HANDLE & EXTERNAL LORA ANTENNA CONNECTORS

The newly upgraded antenna handle incorporates the good capability of impact resistance facing the tough conditions of outdoor fields. The reinforced and thickened antenna casing is better suited for comfort gripping but also does not compromise the antenna's performance. On the contrary, the redesigned antenna can transmit signal data more effectively, providing pilots with a more reliable flying control experience.

The X20R & X20RS are also equipped with 2 external antenna connectors, which can be mounted with additional 2.4G and 900M antennas for enhancing the RF capabilities working under the LoRa modes, to achieve enhanced long-range control.

BUILT-IN MASS STORAGE & TEXT TO SPEECH FUNCTION (X20RS)

To save the user the trouble of deciding the storage capacity, both R and RS versions have a built-in 8GB flash storage that offers big storage to meet all your radio's storage needs with high data transmission speed.

Thanks to the upgraded storage feature, the TTS (Text-to-Speech) function of X20 RS versions can quickly and conveniently convert typed input English words into spoken speech. This enables the ETHOS system to more flexibly match the triggered operational status using generated speech audio when specific functions are activated and to alert clear outdoors with the digital power amplifier module.

DUAL-SIDE HAPTIC GIMBAL FEEDBACK (X20RS)

The gimbal vibration feedback function can be easily enabled or disabled by setting a switch. The dual-sided Gimbal's vibration feedback can operate independently, allowing the configuration to match distinct feedback preferences tailored to various application scenarios for RC enthusiasts.

EASY TRAVEL-ADJUSTABLE MC20R GIMBALS (WITH ANY DESIRED DEGREE BETWEEN 45° TO 60°) (X20RS)

The MC20R Gimbals also has an 8° rotatable panel and can be adjusted to a 45° travel position. What's even better is that the angle is not limited to just 45° and 60°, the MC20R Gimbal allows for adjustment of any travel position between 45° and 60°. To enhance convenience for pilots in outdoor applications, the angle travel position can be directly adjusted using a 1.5mm hexagon screwdriver through the adjustment hole on the Gimbal Panel, eliminating the need to disassemble the radio casing.

Overview

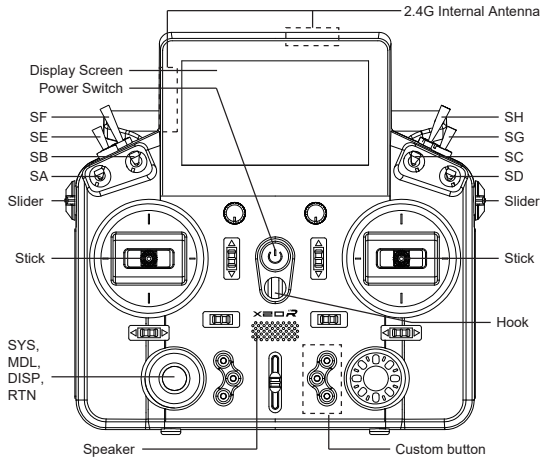

Switch

- SA: 3 positions; Short Lever
- SB: 3 positions; Long Lever
- SC: 3 positions; Long Lever
- SD: 3 positions; Short Lever
- SE: 3 positions; Short Lever
- SF: 2 positions; Long Lever
- SG: 3 positions; Short Lever
- SH: 2 positions; Momentary, Long lever

You can choose the Switch and define its position in the HARDWARE menu.

1. USB port is for upgrading, reading/writing Micro SD cards and internal memory of radio contents and charging. (Micro SD card is not provided with shipment.)
2. Smart Port is for firmware upgrade for all FrSky S.Port devices.

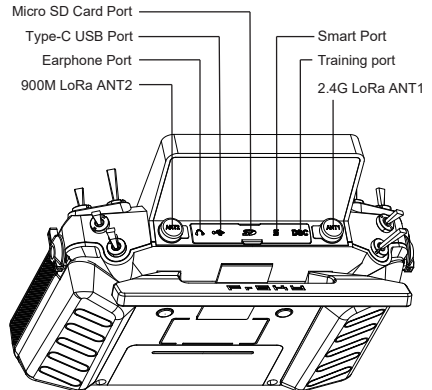
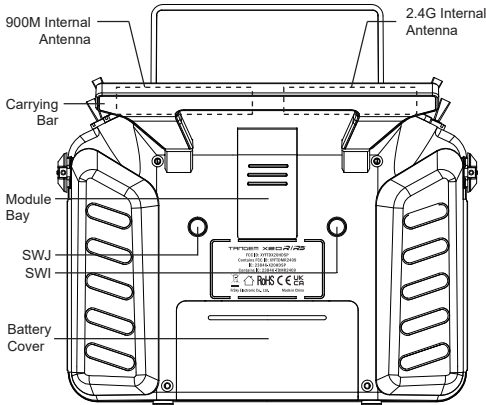

Specifications

- Dimension: 205*213*90mm (L*W*H)
- Weight: 892g (Battery Excl.) / 1024g (Battery Incl.)
- Operating System: ETHOS
- Internal RF module: TD-ISRM RS
- Number of Channels: Up to 24
- Built-in Flash Storage: 8GB
- Operating Voltage Range: 6.5 ~ 8.4V (2S Li-battery)
- Operating Temperature: -10°C~60°C (14°F~140°F)
- Operating Current: 600mA@7.4V (typ.)
- Charging Current: ≤1A ±200mA
- Recharge System for 2S Li-ion Battery (USB Type-C Interface)
- USB Adaptor Voltage: 5V+0.2V
- USB Adaptor Current: >2.0A
- Backlit Touchable LCD Resolution: 800*480
- Compatibility: ACCST D16 & ACCESS & TD & TW receivers
- Lite Type External Module Bay

Features

- Built-in TD-ISRM RS Dual-Band Internal RF Module
 - 900M/2.4G Dual Band TD Mode
 - Dual 2.4G TW Mode
 - ACCESS 2.4G & ACCESS R9 Modes
 - 2.4G ACCST D16 Mode
- Further Improvements for Form Factor Design
- Super Low-Latency and Long-Range Control with Telemetry
- Upgraded Robust Antenna Handle
- 900M/2.4G External Antenna Connectors (LoRa mode)
- 800×480 Resolution Outdoor High Brightness Touchscreen
- 2 Angle Adjustable Slider Levers
- 2 Knobs, 4 Standard Trims with 2 Extra Trims
- 6 Quick-Mode Custom Buttons (Front) and 2 Momentary Buttons (Rear)
- All Knobs, Trims, and Central Linear-Slider with All-CNC Metal Caps
- Built-in 8GB Flash Drive Storage
- Text to Speech (TTS) Function (X20RS)
- Digital Audio Power Amplifier
- Built-in 6-axis Gyroscope Sensor
- High-Speed PARA Wireless Training System
- Data Transmission & Recharge System via USB Type-C Interface
- Haptic Vibration Alerts and Voice Speech Outputs
- M20 High-Precision 4 Ball-Bearing Hall-Sensor Gimbals with Metal Panel (X20R)
- MC20R All CNC High-Precision Hall-Sensor Gimbals with 10 Ball-Bearing (X20RS)
 - Dual-side stick haptic feedback (Left/Right can do vibration independently.)
 - Easy Travel-adjustable with any desired degree from 45° to 60°
 - 8° rotatable panel

2S Li-battery balance charging via USB-C

The Green LED indicator states:

Led on: in charging / **Led off:** end of charge / **Flash:** charge fault

Battery compartment size: 84*41.5*20mm (L*W*H)

- Note:**
1. Charge the battery with the USB adapter (Voltage: 5V+0.2V Current: >2.0A) when you use the USB charging function.
 2. The lower the initial charging voltage, the better the charging effect is when the voltage difference cells exceed 50 mV between the two.

Navigation Controls

The left navigation control does RTN, SYS, MDL, DISP, and Page UP/Down. The right navigation control does scroll and enter. Both navigation controls and touch screen can be used to control the system.

Page Down	Short Click
Page Up	Long Press

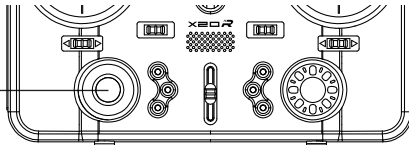

ETHOS Suite

With ETHOS Suite, you can update the radio bootloader, firmware, SD card, flash, and also convert image format and audio format. Find the latest information and download the ETHOS Suite at ethos.frsky-rc.com/.

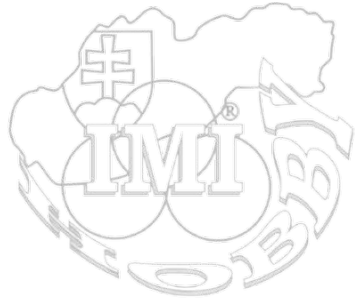
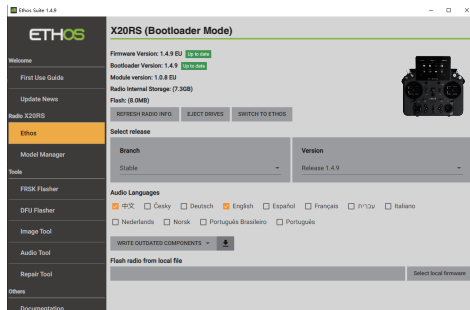

Note: To use the ETHOS Suite application with a FrSky radio, please always keep the radio bootloader with the latest version.

ETHOS Operating System

Create the model

STEP 1:

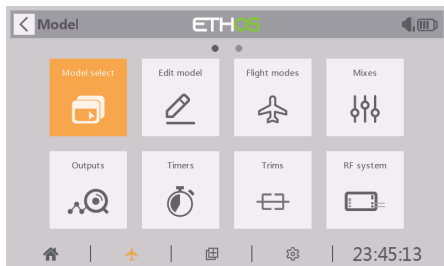

Enter into Model Select, then select the model type.

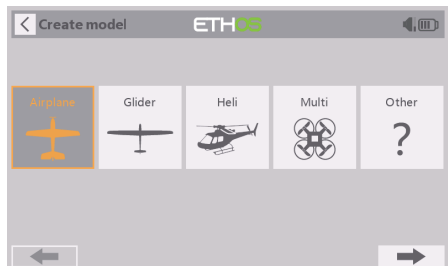

Create a new model.

STEP 2:

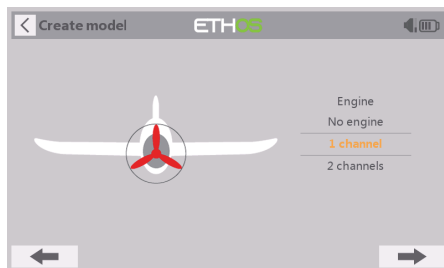

Configure the model channel.

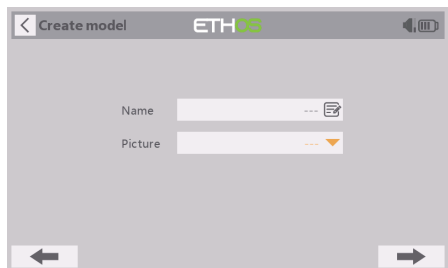

Name the model and set the model picture.

Model Setup Procedure - Internal Module

STEP1: Enable RF Module

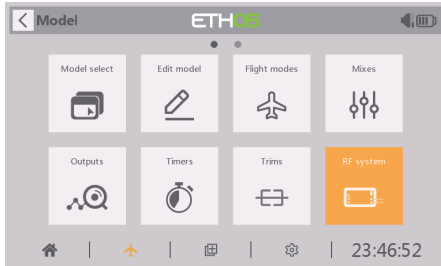

Enter the RF system menu by the touch-screen or use the navigation encoder key.

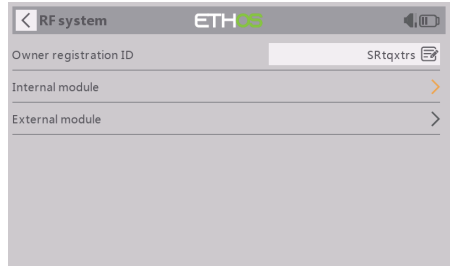

Choose the Internal Module.

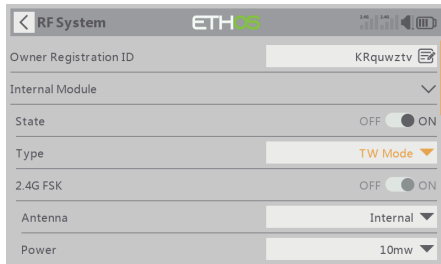

Then turn the state of Internal RF to On. Set the binding mode for the Internal RF module corresponding to the receiver (ACCST D16, ACCESS, TW, TD).

Note: ACCESS 900M mode can be enabled simultaneously while using ACCESS 2.4G mode or Dual 2.4G TW mode with the internal module.

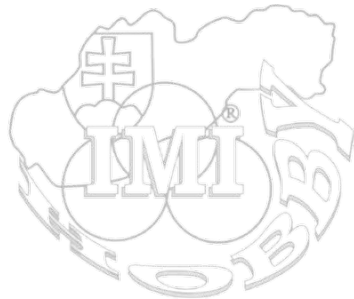

STEP2: Channel Range Setting

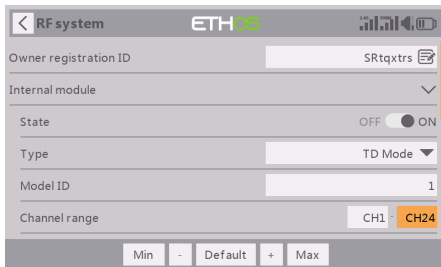

The internal RF module supports 24 channels (CH1-8 / CH1-16 / CH1-24).

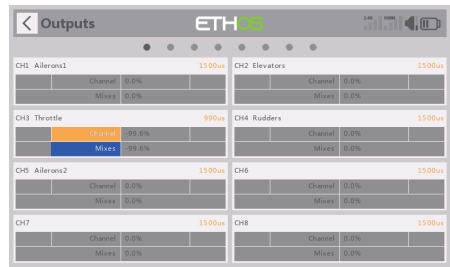

The channel range is configurable by pressing the channel bars, please also make sure of the channel configuration before using the module.

STEP3: Model ID Setting

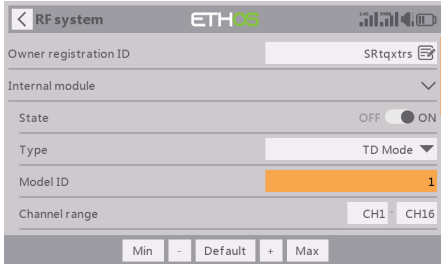

The system assigns the receiver a number for the receiver (Model ID) automatically while creating a new model. (The Model ID can be set from 00 to 63, with the default ID being 1.)

STEP4: Registration

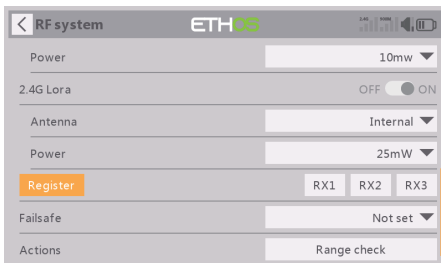

For TW Mode as an example, select the Set [Register] for getting the radio into Registration status in the RF System-Internal Module tool, then press the F/S button on the receiver and power the receiver on.

STEP5: Automatic Binding (Smart Match)

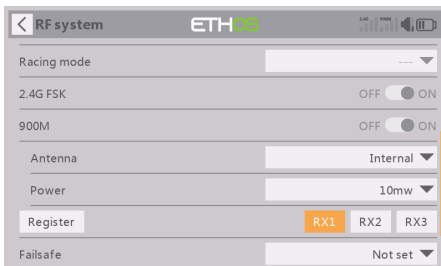

Move the cursor to RX1 [BIND], press it and repower the receiver.

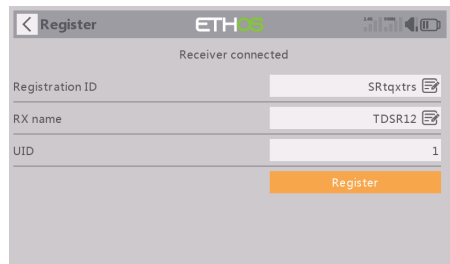
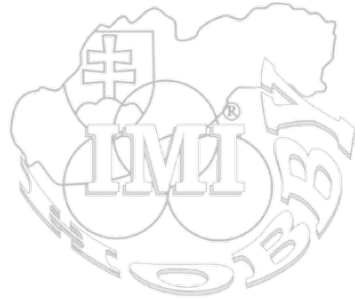

When the "RX Connected" page pops up, press the [REGISTER] to complete the Registration procedure and then power the receiver off.

(The system automatically assigns the receiver a UID differently in the same model when you have several receivers to bind at the same time.)

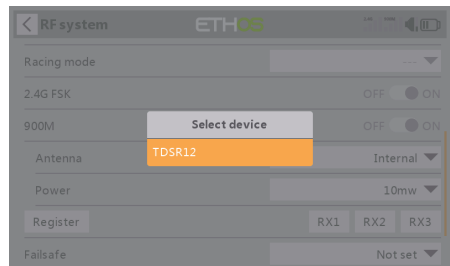

Click the RX to complete the binding after the receiver window pops up, the system will confirm "Bind succeed".

Reset: Registration procedure is not required to repeat anymore after the receiver was once registered even though the receiver is deleted. Pressing the [Reset] and repower the receiver can have the bound recovered.

STEP6: RF Power Setting

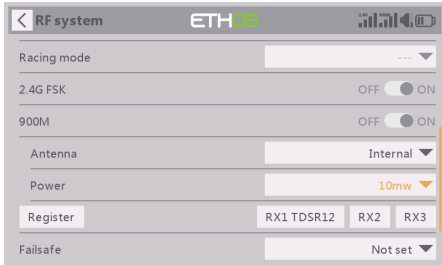

The internal RF Module can offer multiple RF power options which can achieve a further controlling range.



Open the Power menu bar and select the desired power level according to usage.

Range Check

A pre-flight range check should be done before every flight, in case the signal loss is caused by the reflection of the signal by the nearby metal fence or concrete, and the shading of the signal by buildings or trees during the actual flight.

1. Place the model at least 60 cm (2 feet) above the non-metal contaminated ground (such as on a wooden bench). The receiving antenna should be in a vertical position.
2. Enter the ETHOS system, move to the "RF System", scroll the Encoder to select "RANGE" mode and press Encoder. In range check mode, the effective distance will be decreased to 1/30.

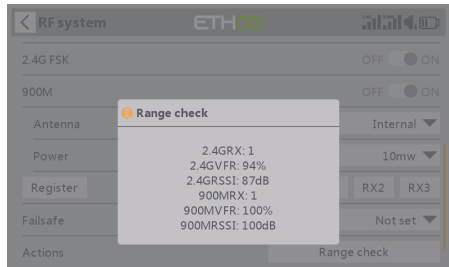
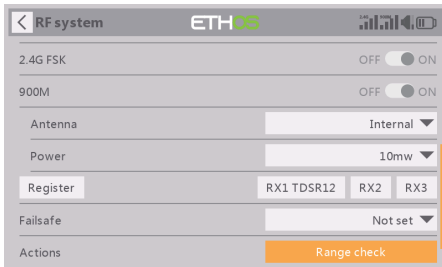

TTS (Text to Speech) Function

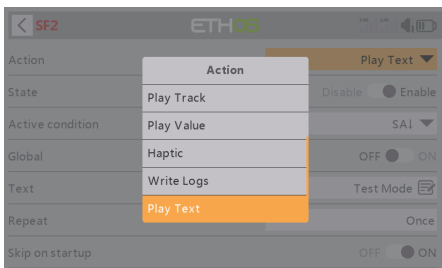

Step 1: Create a Special Function of "Play Text".

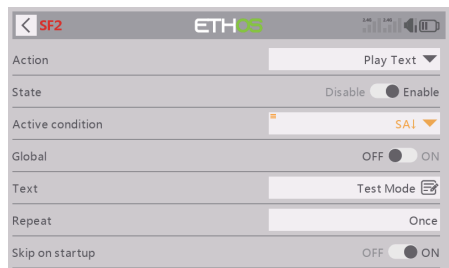

Step 2: Enable the function, and set up an "Active Condition" for it.



Step 3: Done with basic settings by typing into an alphabet letter or English words

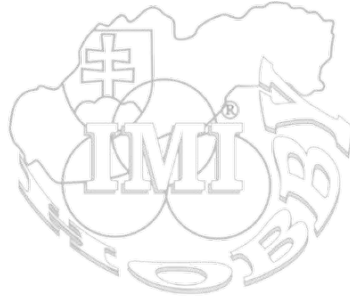

How to set Failsafe

There are 3 failsafe modes when the setting is enabled: No Pulse, Hold, and Custom mode.

- **No Pulses Mode:** On loss of signal, the receiver produces no pulses on any channel. To use this mode, select it in the menu and wait 9 seconds for the failsafe to take effect.
- **Hold Mode:** The receiver continues to output the last positions before the signal was lost. To use this mode, select it in the menu and wait 9 seconds for the failsafe to take effect.
- **Custom Mode:** Pre-set to required positions on the lost signal. Move the cursor to the failsafe mode of the channel and press Encoder, then choose the Custom mode. Move the cursor to the channel you want to set failsafe On and press Encoder. Then rotate the Encoder to set your failsafe for each channel and short-press the Encoder to finish the setting. Wait 9 seconds for the failsafe to take effect.

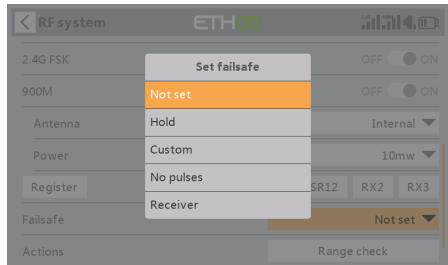
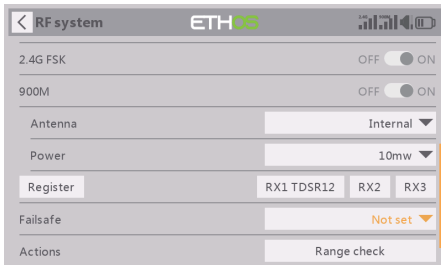

Note:

- If the failsafe is not set, the model will always work with the last working status before the signal is lost. That could cause potential damage.
- When the failsafe is disabled on the RF module side, the failsafe set on the receiver side will be applied.
- SBUS port does not support the failsafe setting in No Pulses mode and always outputs signal. Please set "Hold" or "Custom" mode for the SBUS port.

FCC

This equipment has been tested and found to comply with the limits for a Class B digital device, pursuant to part 15 of the FCC Rules

CE

The product may be used freely in these countries: Germany, UK, Italy, Spain, Belgium, Netherlands, Portugal, Greece, Ireland, Denmark, Luxembourg, Austria, Finland, Sweden, Norway, Switzerland, France and Iceland.

FLYING SAFETY

⚠ Warning:

To ensure the safety of yourself and others, please observe the following precautions.

① **Have regular maintenance performed.** Although your TANDEM X20R & X20RS protects the model memories with non-volatile memory (which does not require periodic replacement) and of a battery, it still should have regular check-ups for wear and tear. We recommend sending your system to your FrSky Service Center annually during your non-flying-season for a complete check-up and service.

Battery

① Using a fully charged battery (DC 6.5~8.4V). A low battery will soon die, causing loss of control and a crash. When you begin your flying session, reset your transmitter's built-in timer, and during the session pay attention to the duration of usage. Also, if your model used a separate receiver battery, make sure it is fully charged before each flying session.

① **Stop flying long before your batteries become over discharged. Do not rely on your radio's low battery warning systems, intended only as a precaution, to tell you when to recharge. Always check your transmitter and receiver batteries prior to each flight.**

Where to Fly

We recommend that you fly at a recognized model airplane flying field. You can find model clubs and fields by asking your nearest hobby dealer.

① **Always pay particular attention to the flying field's rules**, as well as the presence and location of spectators, the wind direction, and any obstacles on the field. Be very careful flying in areas near power lines, tall buildings, or communication facilities as there may be radio interference in their vicinity.

At the flying field

- ① To prevent possible damage to your radio gear, turn the power switches on and off in the proper sequence:
1. Pull throttle stick to idle position, or otherwise disarm your motor/engine.
 2. Turn on the transmitter power and allow your transmitter to reach its home screen.
 3. Confirm the proper model memory has been selected.
 4. Turn on your receiver power.
 5. Test all controls. If a servo operates abnormally, don't attempt to fly until you determine the cause of the problem.
 6. Start your engine.
 7. Complete a full range check.
 8. After flying, bring the throttle stick to idle position, engage any kill switches or otherwise disarm your motor/engine.

If you do not turn on your system on and off in this order, you may damage your servos or control surfaces, flood your engine, or in the case of electric-powered or gasoline-powered models, the engine may unexpectedly turn on and cause a severe injury.

① **Make sure your transmitter can't tip it over.** If it is knocked over, the throttle stick may be accidentally moved, causing the engine to speed up. Also, damage to your transmitter may occur.

① In order to maintain complete control of your aircraft it is important that it remains visible at all times. Flying behind large objects such as buildings, grain bins, etc. must be avoided. Doing so may interrupt the radio frequency link to the model, resulting in loss of control.

- ⊗ Do not grasp the transmitter's antenna during flight. Doing so may degrade the quality of the radio frequency transmission and could result in loss of control.
- ⊗ As with all radio frequency transmissions, the strongest area of signal transmission is from the sides of the transmitter's antenna.
- ① **Don't fly in the rain!** Water or moisture may enter the transmitter through the antenna or stick openings and cause erratic operation or loss of control. If you must fly in wet weather during a contest, be sure to cover your transmitter with a plastic bag or waterproof barrier. Never fly if lightning is expected.

Updates

FrSky is continuously adding features and improvements to our radio systems. Updating (via USB Port or the Micro SD card) is easy and free. To get the most from your new transmitter, please check the download section of the FrSky website for the latest update firmware and guide for adjusting your sticks. (www.frsky-rc.com)

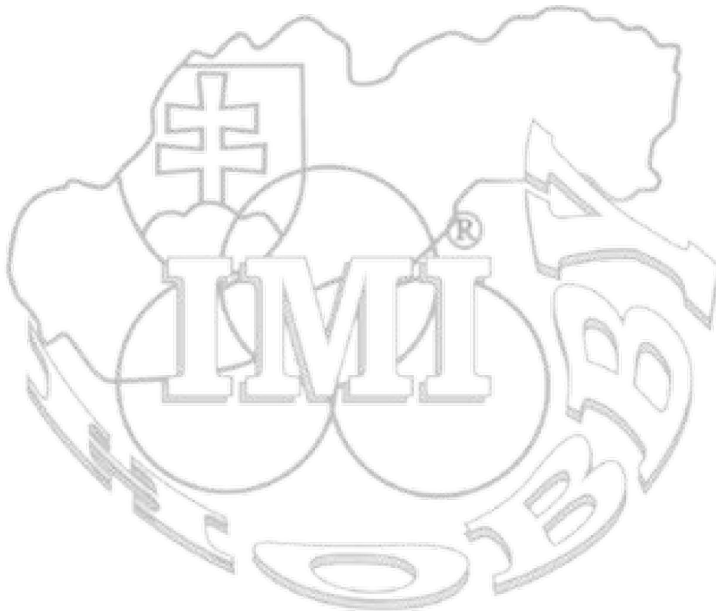

www.modelsport.sk

FrSky is continuously adding features and improvements to our products. To get the most from your product, please check the download section of the FrSky website www.frsky-rc.com for the latest update firmware and manuals