

MAXI LIFT 33cc

“ Graphics and specifications may change without notice “ .

Code: SEA209



Specifications:

Wingspan-----87.6 in (222.2 cm).

Wing area-----1072.6sq.in (69.2 sq.dm).

Weight-----11.5 - 12.1 lbs (5.2 - 5.5 kg).

Length-----61.2 in (155.5cm).

Recommended engine size 33cc.....

Radio-----7 channels with 10 servos.

Flying skill level intermediate/ advanced

INTRODUCTION.

Thank you for choosing the **MAXI LIFT** ARF by **SG MODELS** . The **MAXI LIFT** was designed with the intermediate/advanced sport flyer in mind. It is a semi scale airplane which is easy to fly and quick to assemble. The airframe is conventionally built using balsa, plywood to make it stronger than the average ARF, yet the design allows the aeroplane to be kept light. You will find that most of the work has been done for you already. The motor mount has been fitted and the hinges are pre-installed. Flying the **MAXI LIFT** is simply a joy.

This instruction manual is designed to help you build a great flying aeroplane. Please read this manual thoroughly before starting assembly of your **MAXI LIFT**. Use the parts listing below to indentify all parts.

WARNING.

Please be aware that this aeroplane is not a toy and if assembled or used incorrectly it is capable of causing injury to people or property. WHEN YOU FLY THIS AEROPLANE YOU ASSUME ALL RISK & REPONSIBILITY.

If you are inexperienced with basic R/C flight we strongly recommend you contact your R/C supplier and join your local R/C model Flying Club. R/C Model Flying Clubs offer a variety of training procedures designed to help the new pilot on his way to successful R/C flight. They will also be able to advise on any insurance and safety regulations that may apply.

KIT CONTENTS

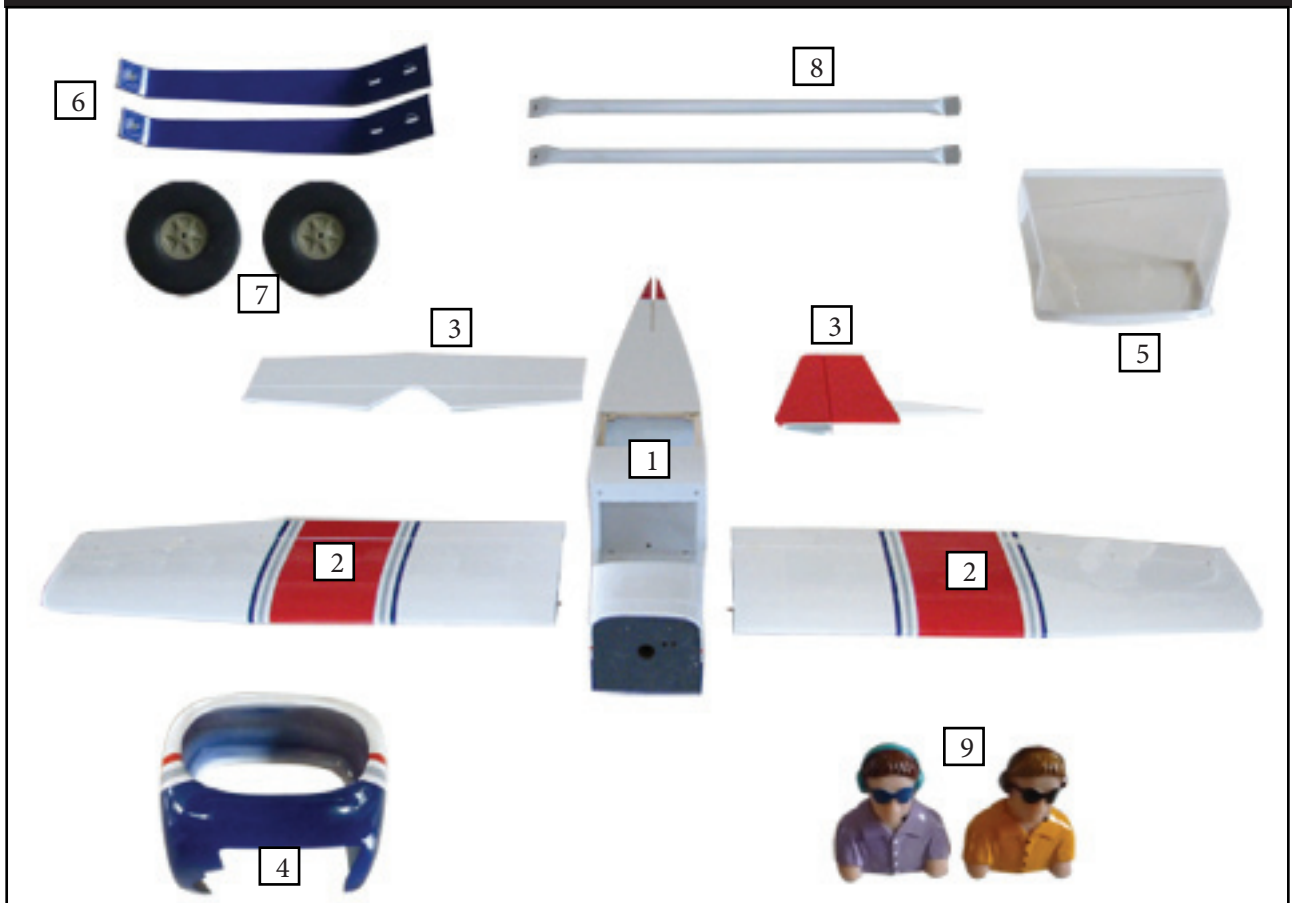

KIT CONTENTS.

- SEA20901 Fuselage
- SEA20902 Wing Set
- SEA20903 Tail Set
- SEA20904 Fiberglass Cowling
- SEA20905 Canopy
- SEA20906 Landing Gear
- SEA20907 Wheels
- SEA20908 Wing struts
- SEA20909 Pilot

ADDITIONAL ITEMS REQUIRED.

- 0.75- 0.91 2-stroke.
- 0.91-1.25 4-stroke.
- 33cc gasoline engine.
- Computer radio with 10 servos.
- Glow plug to suit engine.
- Propeller to suit engine.
- Protective foam rubber for radio system.

TOOLS & SUPPLIES NEEDED.

- Thick cyanoacrylate glue.
- 30 minute epoxy.
- 5 minute epoxy.
- Hand or electric drill.
- Assorted drill bits.
- Modelling knife.
- Straight edge ruler.
- 2mm ball driver.
- Phillips head screwdriver.
- 220 grit sandpaper.
- 90° square or builder's triangle.
- Wire cutters.
- Masking tape & T-pins.
- Thread-lock.
- Paper towels.

HINGING THE FLAP

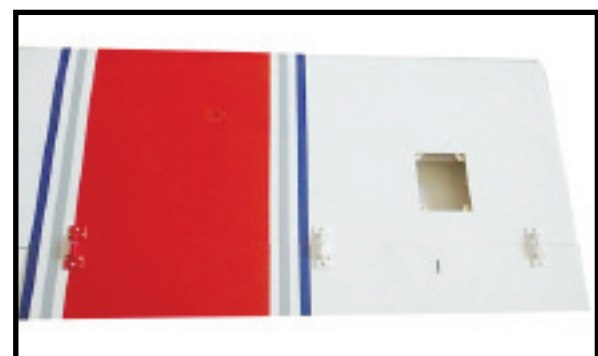
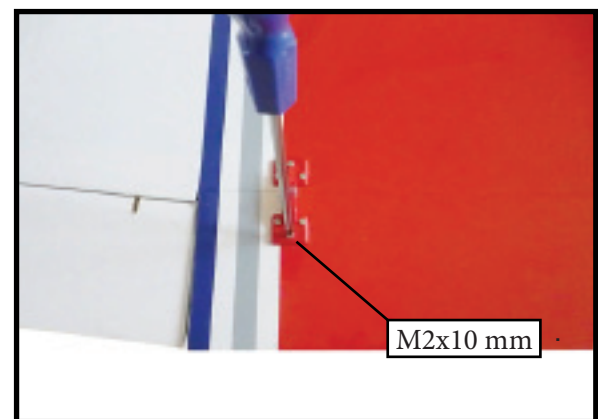
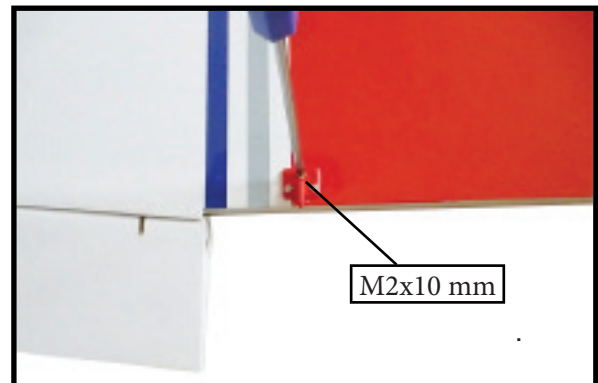
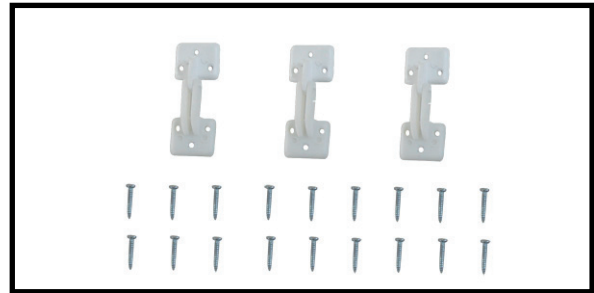

HINGING THE ELEVATOR.

Note : The control surfaces, including the ailerons, elevators, and rudder, are prehinged with hinges installed, but the hinges are not glued in place. It is imperative that you properly adhere the hinges in place per the steps that follow using a high-quality thin C/A glue.

1) Carefully remove the aileron from one of the wing panels. Note the position of the hinges.

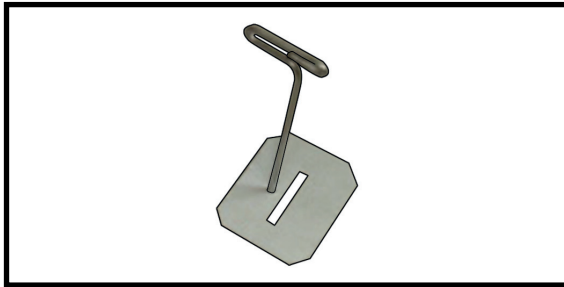

2) Remove each hinge from the wing panel and aileron and place a T-pin in the center of each hinge. Slide each hinge into the wing panel until the T-pin is snug against the wing panel. This will help ensure an equal amount of hinge is on either side of the hinge line when the aileron is mounted to the aileron.

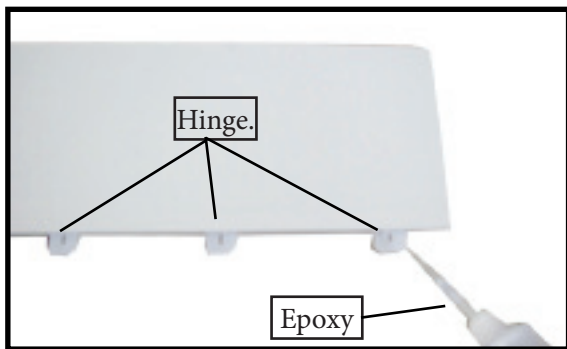

3) Slide the wing panel on the aileron until there is only a slight gap. The hinge is now centered on the wing panel and aileron. Remove the T-pins and snug the aileron against the wing panel. A gap of 1/64" or less should be maintained between the wing panel and aileron.

4) Deflect the aileron and completely saturate each hinge with thin C/A glue. The ailerons front surface should lightly contact the wing during this procedure. Ideally, when the hinges are glued in place, a 1/64" gap or less will be maintained throughout the length of the aileron to the wing panel hinge line.

NOTE : The hinge is constructed of a special material that allows the C/A to wick or penetrate and distribute throughout the hinge, securely bonding it to the wood structure of the wing panel and aileron.

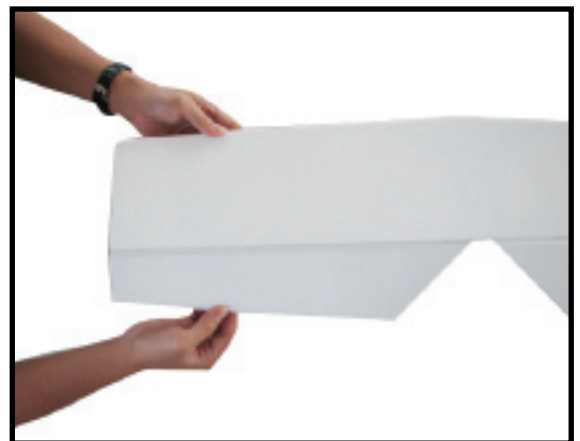
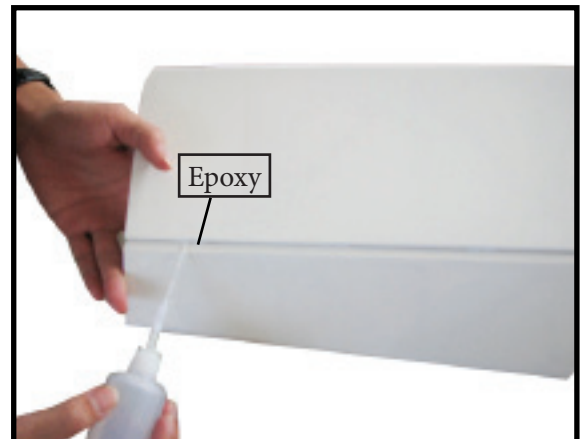
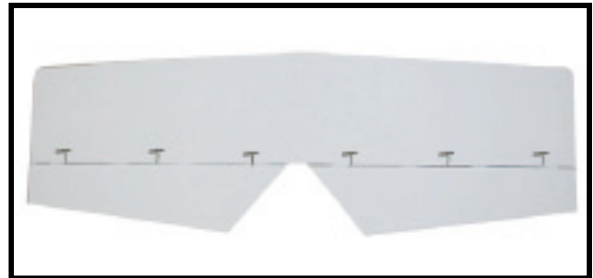

5) Turn the wing panel over and deflect the aileron in the opposite direction from the opposite side. Apply thin C/A glue to each hinge, making sure that the C/A penetrates into both the aileron and wing panel.

6) Using C/A remover/debonder and a paper towel, remove any excess C/A glue that may have accumulated on the wing or in the aileron hinge area.

7) Repeat this process with the other wing panel, securely hinging the aileron in place.

8) After both ailerons are securely hinged, firmly grasp the wing panel and aileron to make sure the hinges are securely glued and cannot be pulled out. Do this by carefully applying medium pressure, trying to separate the aileron from the wing panel. Use caution not to crush the wing structure.

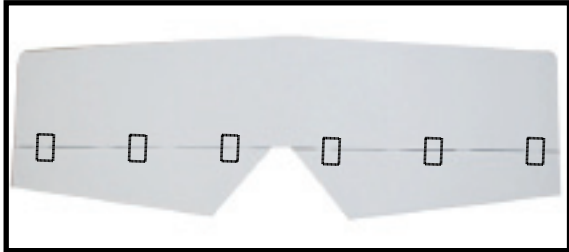

Note : Work the aileron up and down several times to “work in” the hinges and check for proper movement.

HINGING THE RUDDER.

Glue the rudder hinges in place using the same techniques used to hinge the ailerons.

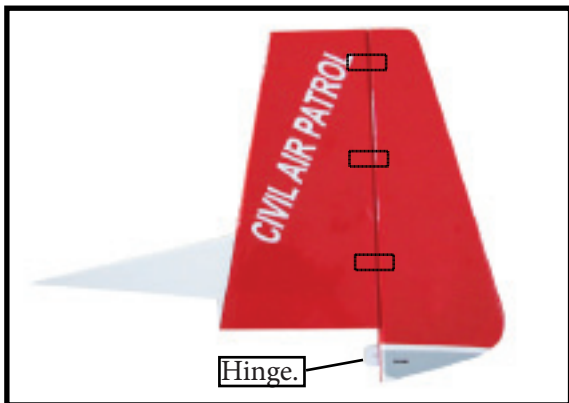

INSTALL THE AILERONS CONTROL HORN.

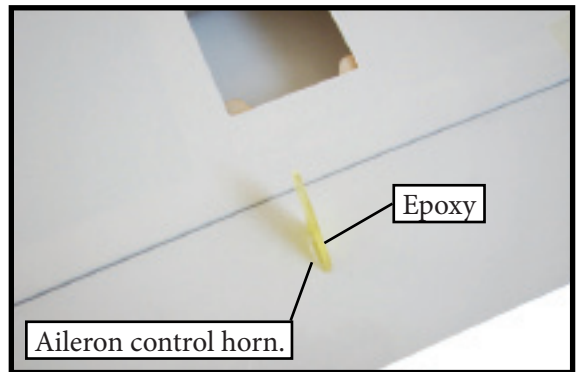
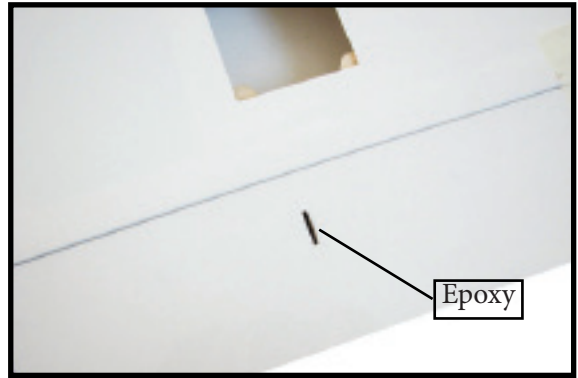
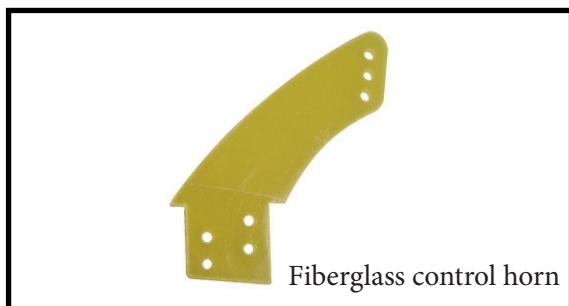

INSTALL FLAP CONTROL HORN.

Install the flap control horn using the same method as same as the aileron control horns.

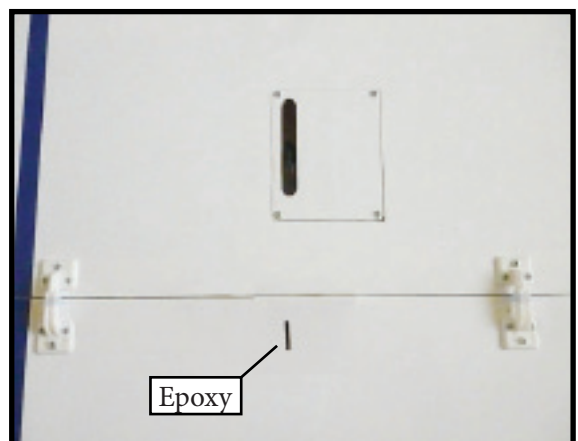
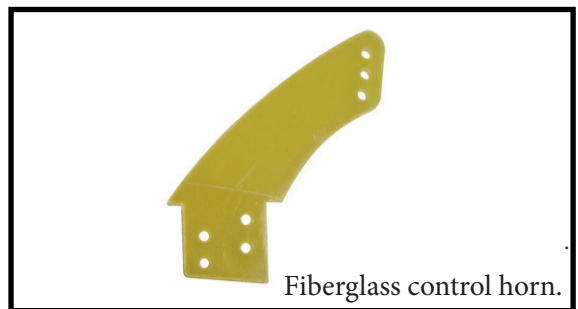

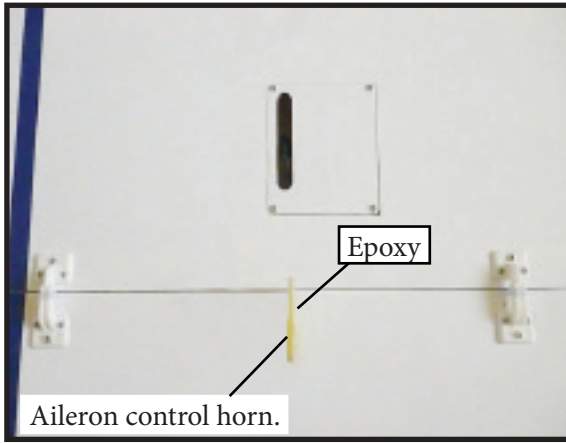

INSTALL ELEVATOR CONTROL HORN.

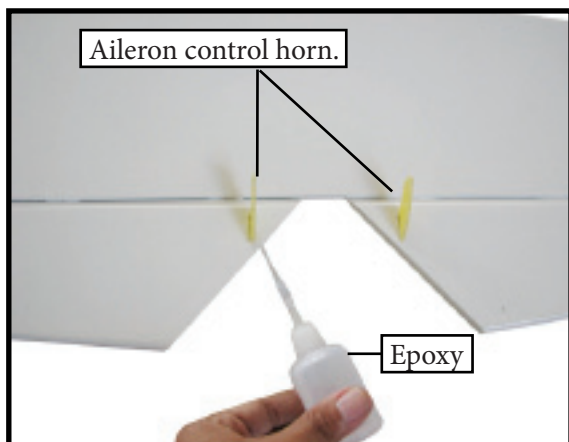
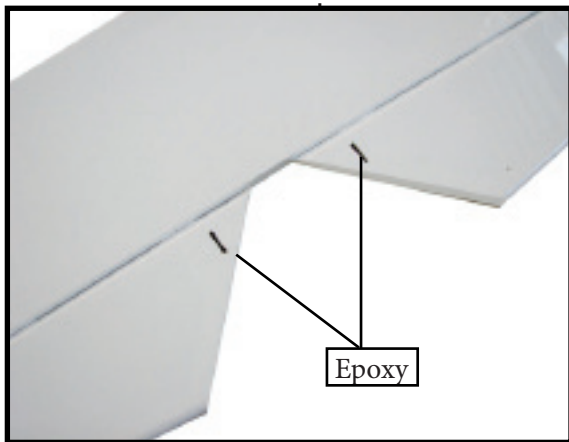
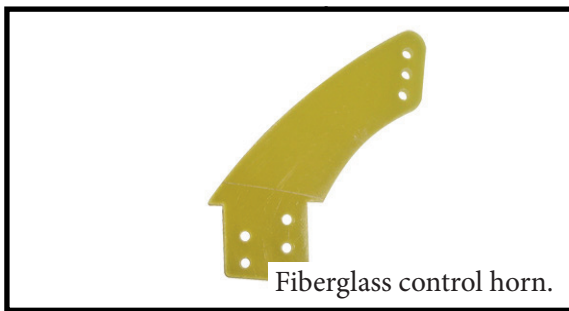

INSTALL RUDDER CONTROL HORN.

Repeat steps to install the rudder control horn as same as steps done for ailerons.

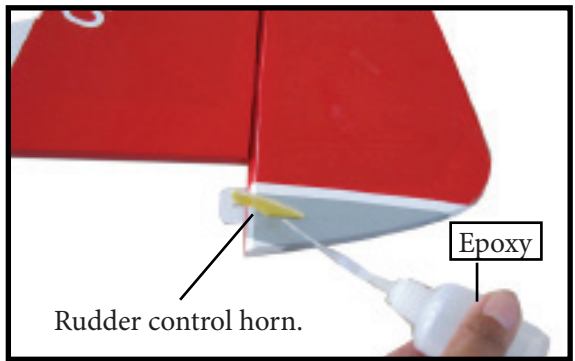
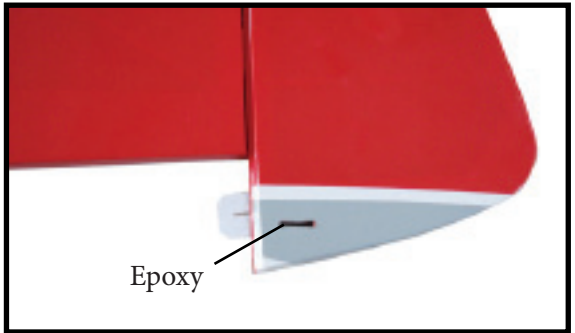
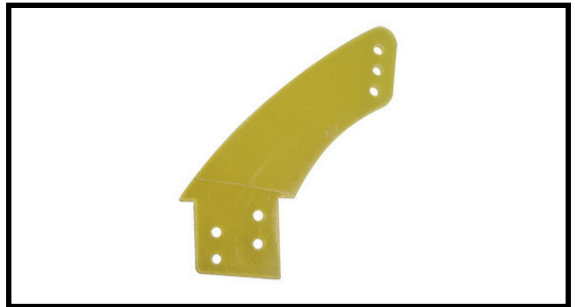

INSTALLING THE MAIN LANDING GEAR.

- 1) The blind nuts for securing the landing gear are already mounted inside the fuselage.
- 2) Using the hardware provided, mount the main landing gear to the fuselage.



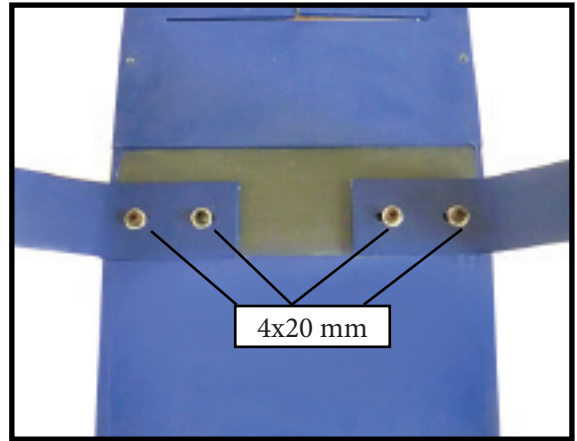
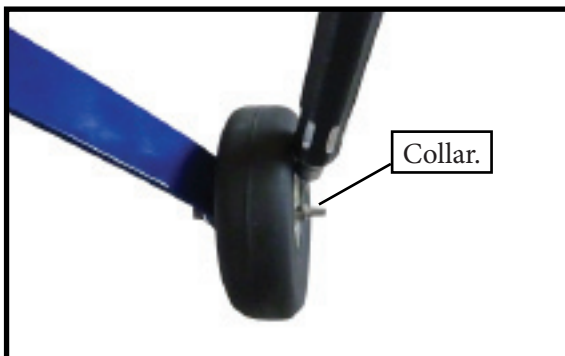
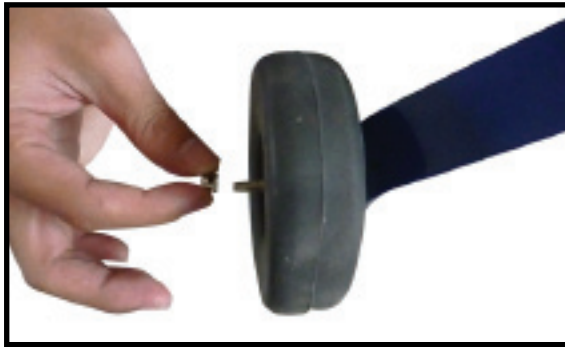
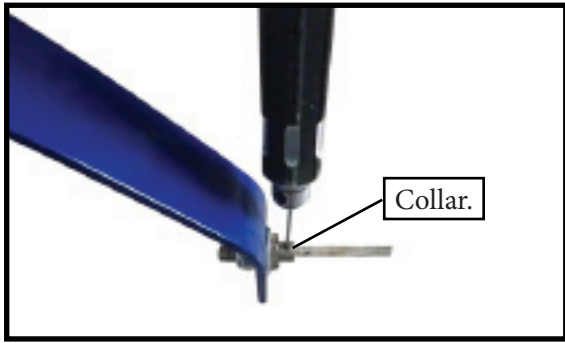

INSTALLING THE FUSELAGE SERVOS.

 Because the size of servos differ, you may need to adjust the size of the precut opening in the mount. The notch in the sides of the mount allow the servo lead to pass through.

- 1) Install the rubber grommets and brass collets onto the throttle servo. Test fit the servo into the aileron servo mount.
- 2) Secure the servos with the screws provided with your radio system.



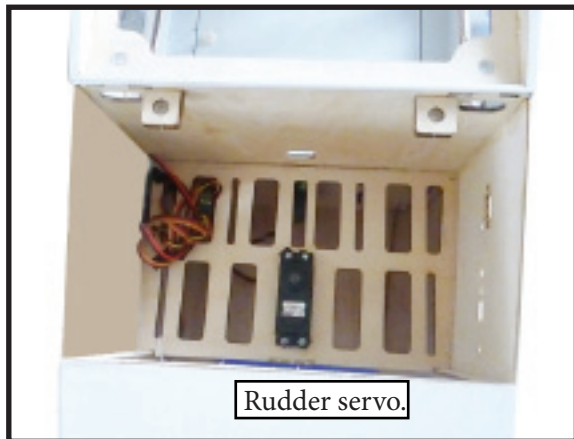
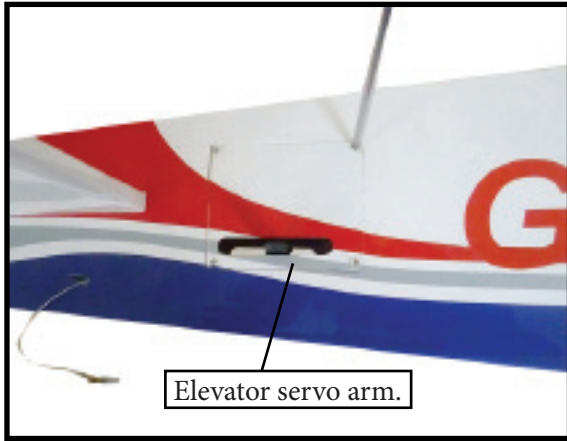

INSTALLING THE SWITCH.

Install the switch into the precut hole in the side, in the fuselage.

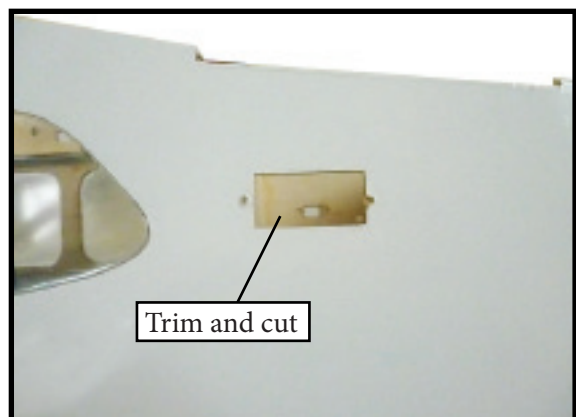
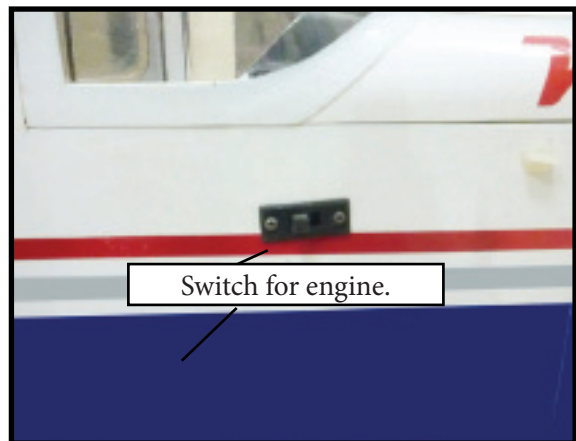
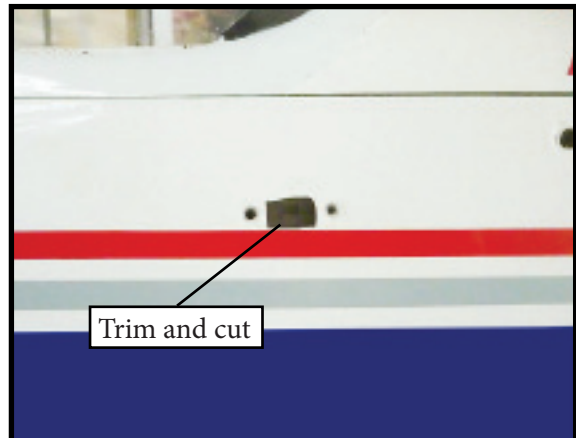
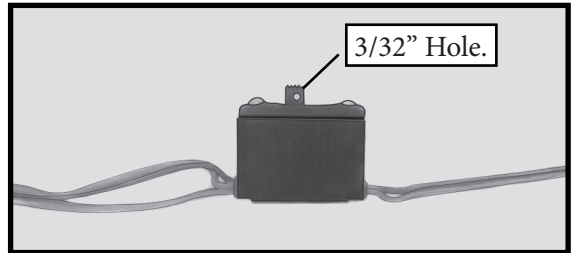

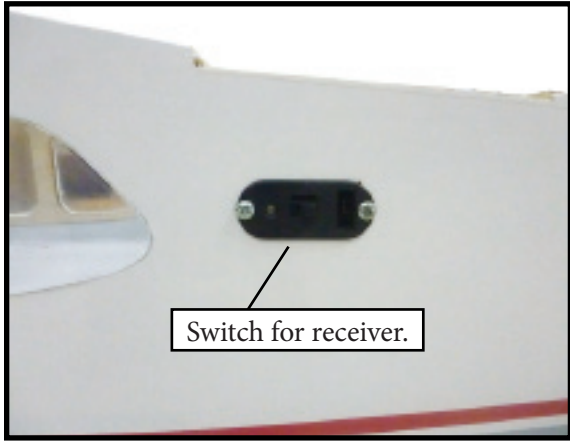

MOUNTING THE ENGINE.

1) Please see below pictures.



2) Use a pin drill and 5mm drill bit to drill a small indentation in the mount for the engine mounting screw.

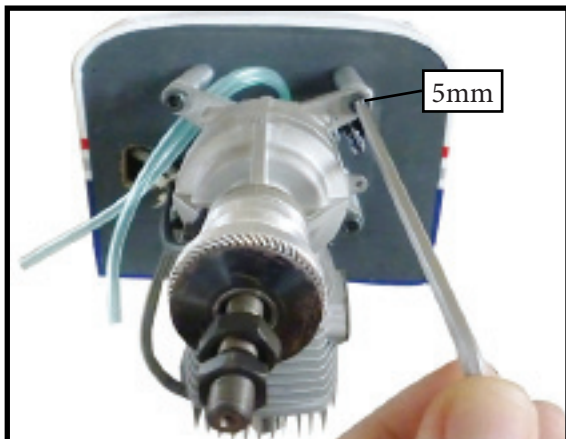

3) Use a drill to drill the four holes in the engine mount rails.

4) On the fire wall has the location for the throttle pushrod tube (pre-drill).

5) Slide the pushrod tube in the firewall and guide it through the fuel tank mount. Use medium C/A to glue the tube to the firewall and the fuel tank mount.

6) Connect the Z-bend in the 600mm throttle pushrod to the outer hole of the carburetor arm.

7) Slide the throttle pushrod wire into the tube. Position the engine between the mounts. Use four M4x30mm machine screws to secure the engine to the mount as shown.

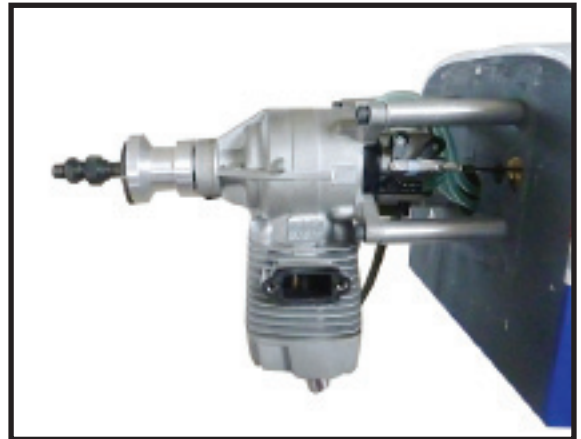

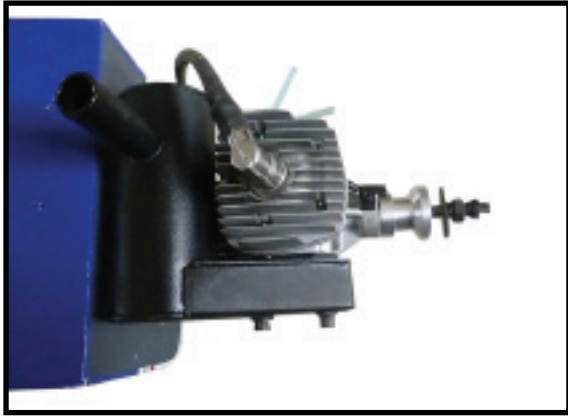

8) Move the throttle stick to the closed position and move the carburetor to closed. Use a 2.5mm hex wrench to tighten the screw that secures the throttle pushrod wire. Make sure to use threadlock on the screw so it does not vibrate loose.

THROTTLE SERVO ARM INSTALLATION.

Install adjustable servo connector in the servo arm as same as picture below:

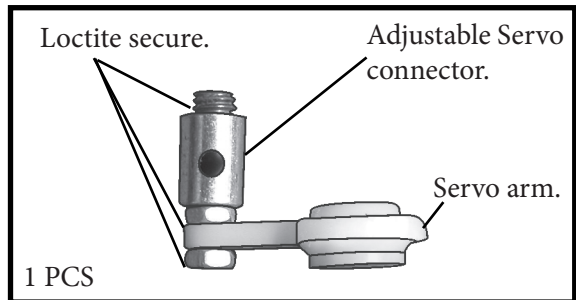

INSTALLING THE STOPPER ASSEMBLY.

1) Using a modeling knife, carefully cut off the rear portion of one of the 3 nylon tubes leaving 1/2" protruding from the rear of the stopper. This will be the fuel pick up tube.

2) Using a modeling knife, cut one length of silicon fuel line. Connect one end of the line to the weighted fuel pick up and the other end to the nylon pick up tube.

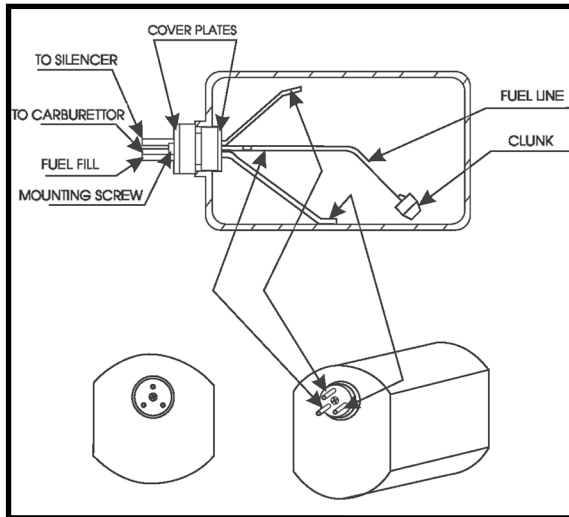

5) With the stopper assembly in place, the weighted pick-up should rest away from the rear of the tank and move freely inside the tank. The top of the vent tube should rest just below the top of the tank. It should not touch the top of the tank.

6) When satisfied with the alignment of the stopper assembly tighten the 3 x 20mm machine screw until the rubber stopper expands and seals the tank opening. Do not over-tighten the assembly as this could cause the tank to split.



FUEL TANK INSTALLATION.

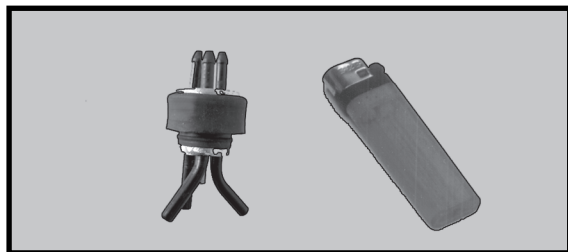
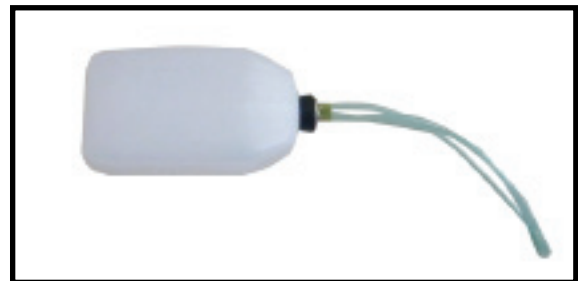

! *You should mark which tube is the vent and which is the fuel pickup when you attach fuel tubing to the tubes in the stopper. Once the tank is installed inside the fuselage, it may be difficult to determine which is which.*

7) Slide the fuel tank into the fuselage. Guide the lines from the tank through the hole in the firewall.

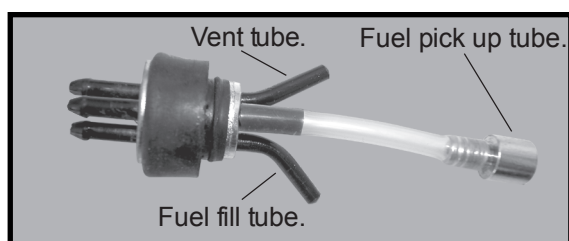

3) Carefully bend the second nylon tube up at a 45° angle. This tube is the vent tube.

4) Test fit the stopper assembly into the tank. It may be necessary to remove some of the flashing around the tank opening using a modeling knife. If flashing is present, make sure none falls into the tank.

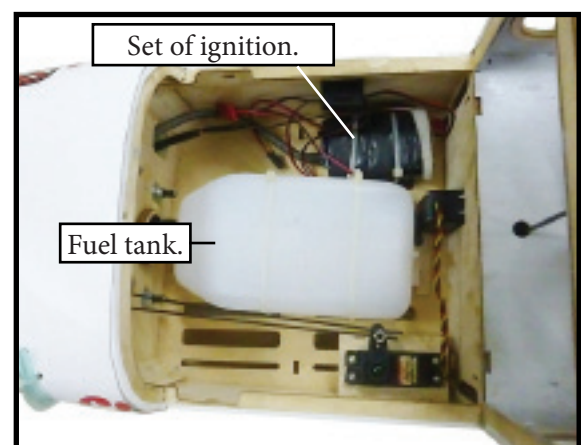

8) Use plywood template to hold in place the fuel tank with C/A glue to secure the fuel tank inside the fuselage.

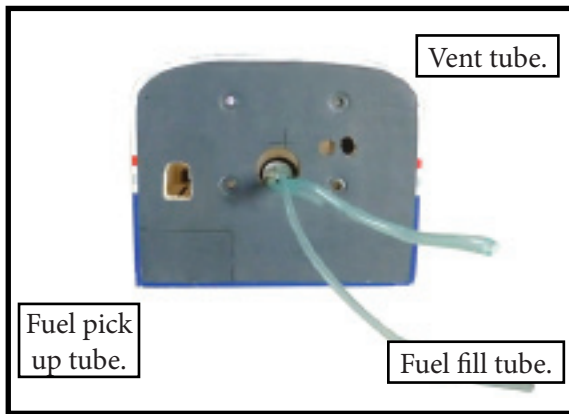

9) Connect the lines from the tank to the engine and muffler. The vent line will connect to the muffler and the line from the clunk to the carburetor.



 Blow through one of the lines to ensure the fuel lines have not become kinked inside the fuel tank compartment. Air should flow through easily.

COWLING

1) Slide the fiberglass cowl over the engine and line up the back edge of the cowl with the marks you made on the fuselage then trim and cut as shown.

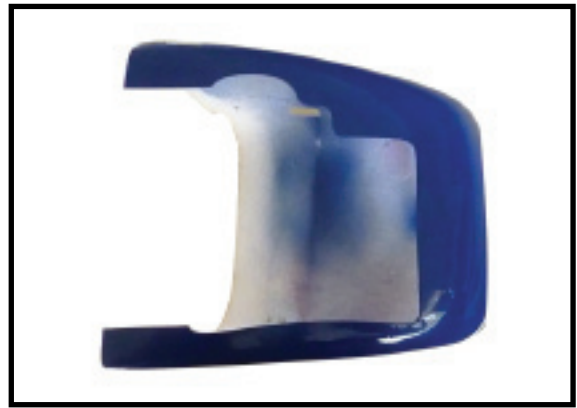

Because of the size of the cowl, it may be necessary to use a needle valve extension for the high speed needle valve. Make this out of sufficient length 1.5mm wire and install it into the end of the needle valve. Secure the wire in place by tightening the set screw in the side of the needle valve.





2) While keeping the back edge of the cowl flush with the marks, align the front of the cowl with the crankshaft of the engine. The front of the cowl should be positioned so the crankshaft is in **nearly** the middle of the cowl opening. Use the spinner backplate as a guide. Hold the cowl firmly in place using pieces of masking tape.



3) Install the muffler and muffler extension onto the engine and make the cutout in the cowl for muffler clearance. Connect the fuel and pressure lines to the carburetor, muffler and fuel filler valve. Secure the cowl to fuselage using the M3x10mm screws.

INSTALLING THE SPINNER.

Install the spinner backplate, propeller and spinner cone.



! The propeller should not touch any part of the spinner cone. If it does, use a sharp modeling knife and carefully trim away the spinner cone where the propeller comes in contact with it.



INSTALLING THE AILERON - FLAP SERVOS.

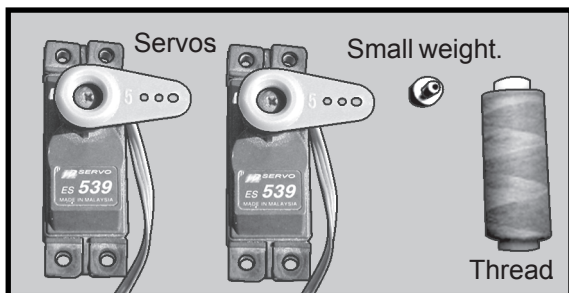

! Because the size of servos differ, you may need to adjust the size of the precut opening in the mount. The notch in the sides of the mount allow the servo lead to pass through.

1) Using a small weight (Weighted fuel pick-up works well) and string, feed the string through the wing as indicated.

2) Place the servo between the mounting blocks and space it from the hatch. Use a pencil to mark the mounting hole locations on the blocks.

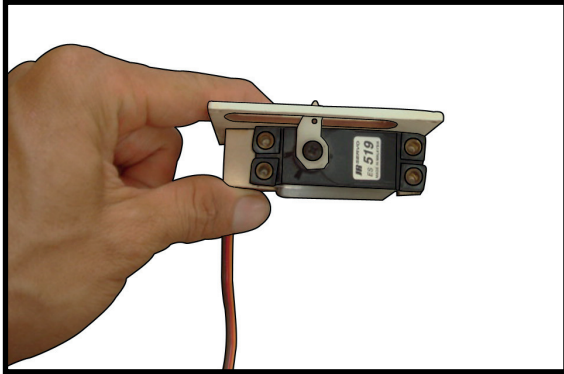

3) Use drill bit in a pin vise to drill the mounting holes in the blocks.

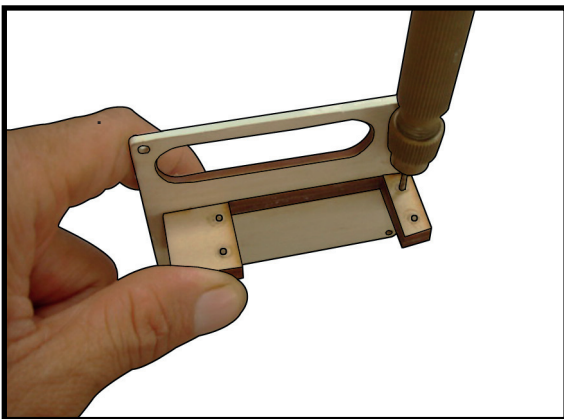

4) Apply 2-3 drops of thin C/A to each of the mounting holes. Allow the C/A to cure without using accelerator.

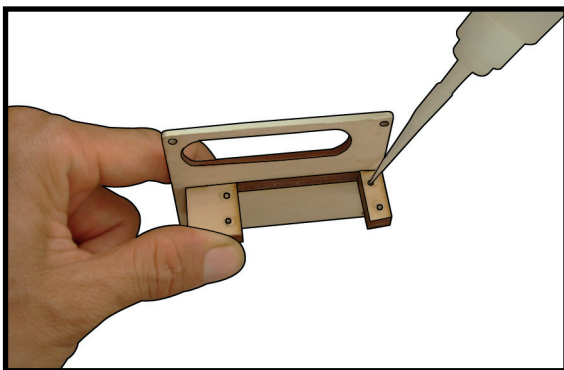

5) Use dental floss to secure the connection so they cannot become unplugged.

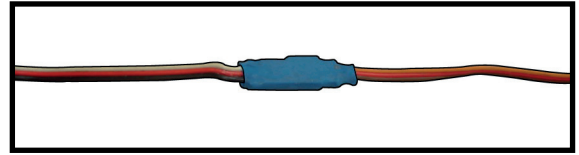

6) Secure the servo to the aileron hatch using Phillips screwdriver and the screws provided with the servo.

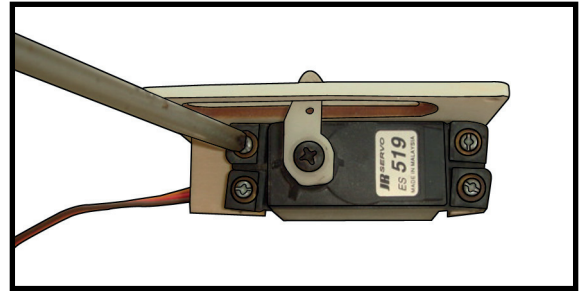

7) Apply 1-2 drops of thin C/A to each of the mounting tabs. Allow the C/A to cure without using accelerator.



8) A string has been provided in the wing to pull the aileron lead through to the wing root. Remove the string from the wing at the servo location and use the tape to attach it to the servo extension lead. Pull the lead through the wing and remove the string.

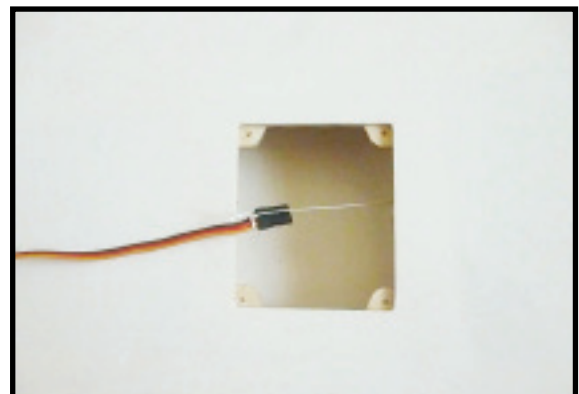

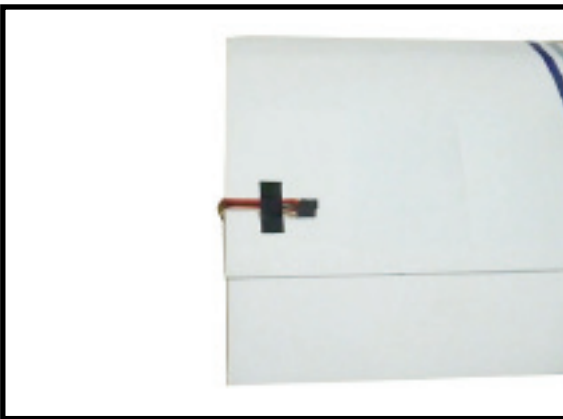
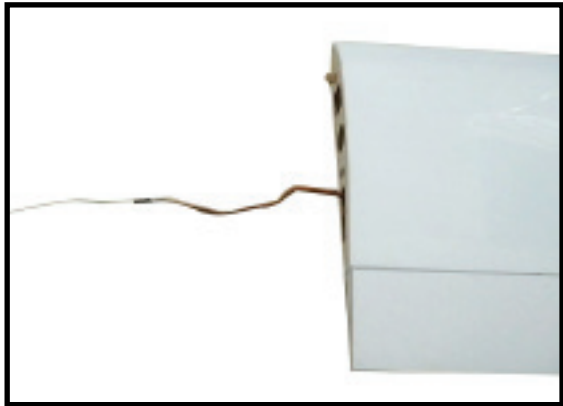
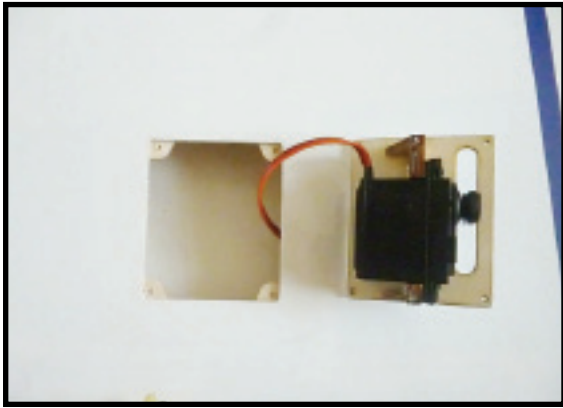

9) Set the aileron hatch in place and use a Phillips screw driver to install it with four wood screws.

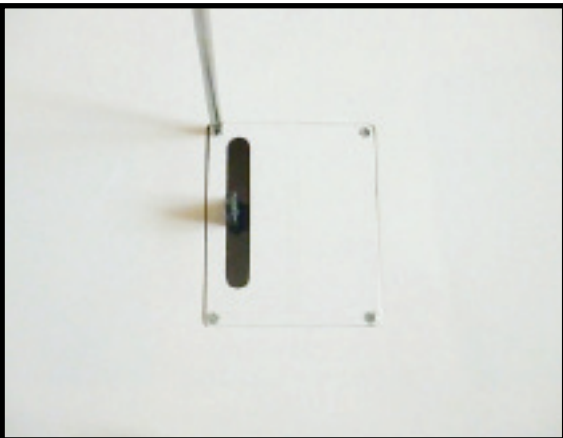

AILERON PUSHROD INSTALLATION.

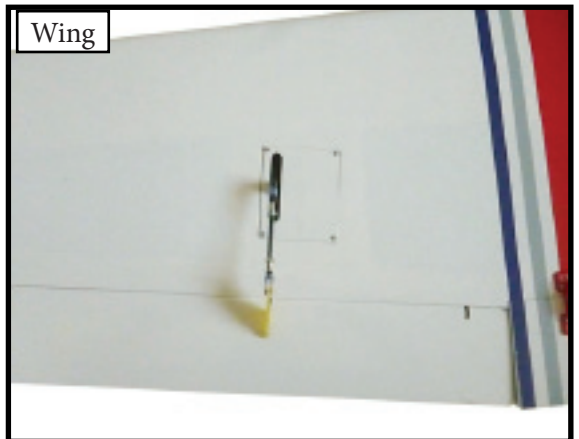
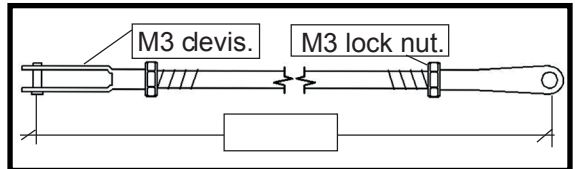
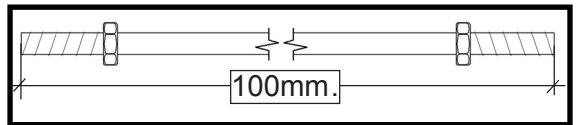
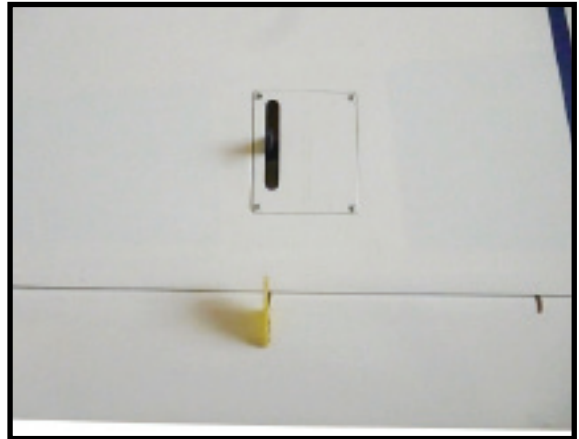

INSTALLING THE FLAP SERVO.

Repeat the procedure for the aileron servo.

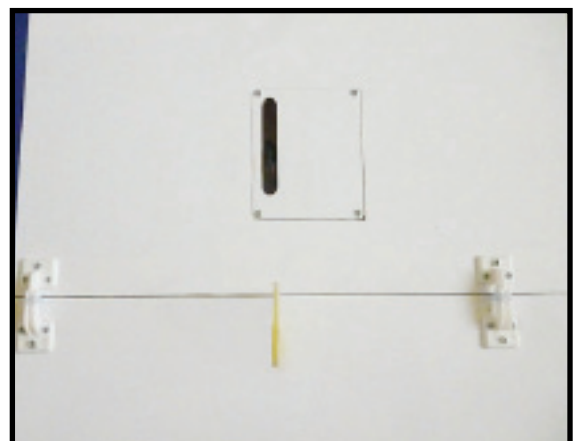

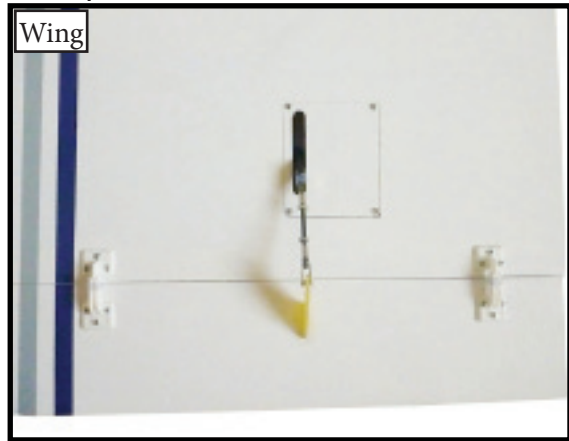
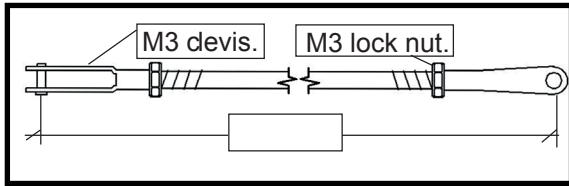
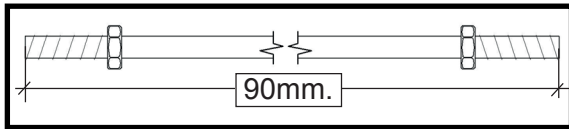

INSTALLING TOW RELEASE FOR SAIL PLANE.

Screw the aero-tow mechanism into the hole just behind the canopy, and apply thread-lock fluid to prevent the coupling and nut from working loose.

The aluminium part must be shortened enough so that the clevis can move freely, adjust the rods accordingly.



It is best to operate the aero-tow release mechanism using a momentary switch mounted on the joystick. The servo travel must be set accordingly.

INSTALLING THE HATCH OF BELLY FUSELAGE.

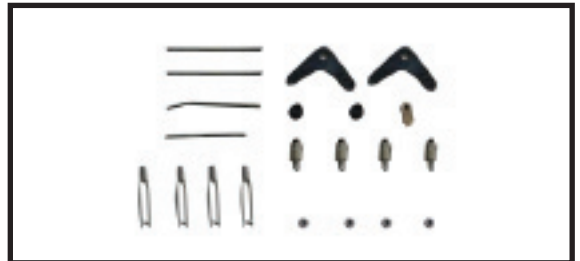

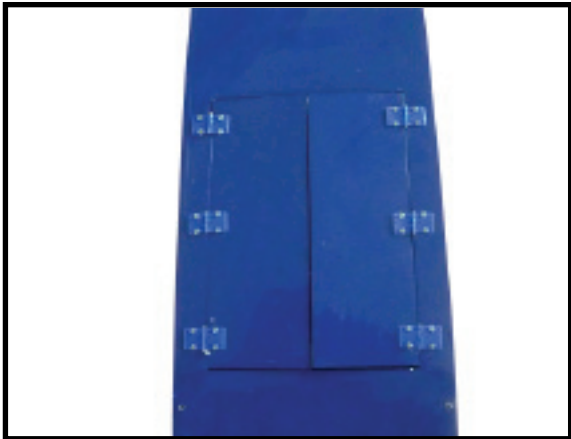
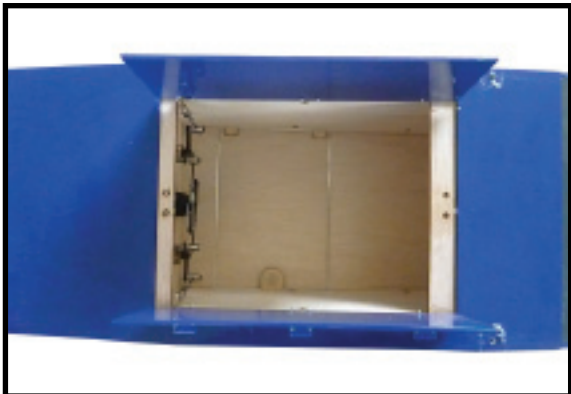

INSTALLING THE HORIZONTAL STABILIZER.

1) Using a ruler and a pen, locate the center-line of the horizontal stabilizer, at the trailing edge, and place a mark. Use a triangle and extend this mark, from back to front, across the top of the stabilizer. Also extend this mark down the back of the trailing edge of the stabilizer.

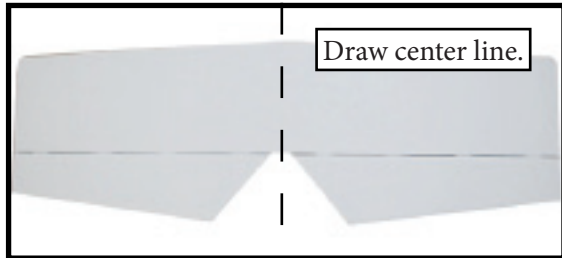

2) Using a modeling knife, carefully remove the covering at mounting slot of horizontal stabilizer (both side of fuselage).

3) Slide the stabilizer into place in the precut slot in the rear of the fuselage. The stabilizer should be pushed firmly against the front of the slot.



4) With the stabilizer held firmly in place, use a pen and draw lines onto the stabilizer where it and the fuselage sides meet. Do this on both the right and left sides and top and bottom of the stabilizer.

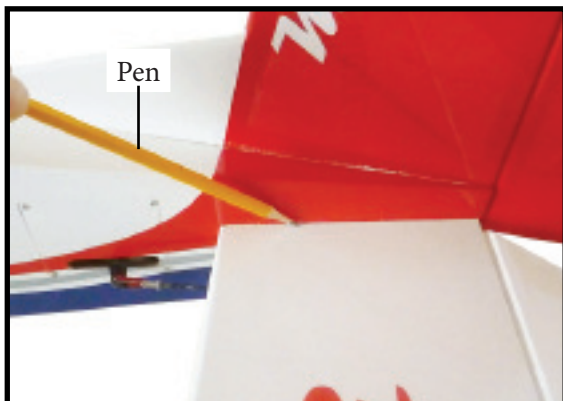

5) Remove the stabilizer. Using the lines you just drew as a guide, carefully remove the covering from between them using a modeling knife.

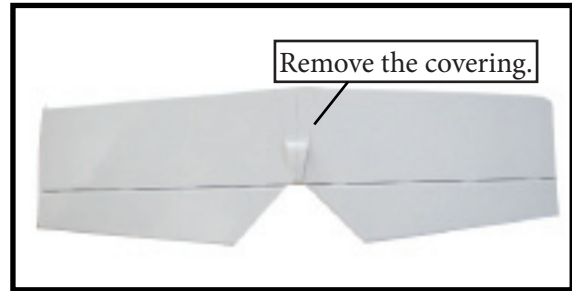

 When cutting through the covering to remove it, cut with only enough pressure to only cut through the covering itself. Cutting into the balsa structure may weaken it.

6) Using a modeling knife, carefully remove the covering that overlaps the stabilizer mounting platform sides in the fuselage. Remove the covering from both the top and the bottom of the platform sides.

7) When you are sure that everything is aligned correctly, mix up a generous amount of 30 Minute Epoxy. Apply a thin layer to the top and bottom of the stabilizer mounting area and to the stabilizer mounting platform sides in the fuselage. Slide the stabilizer in place and realign. Double check all of your measurements once more before the epoxy cures. Hold the stabilizer in place with T-pins or masking tape and remove any excess epoxy using a paper towel and rubbing alcohol.

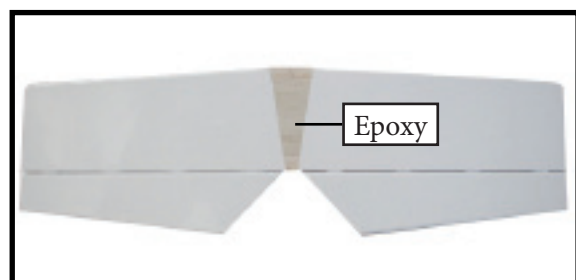

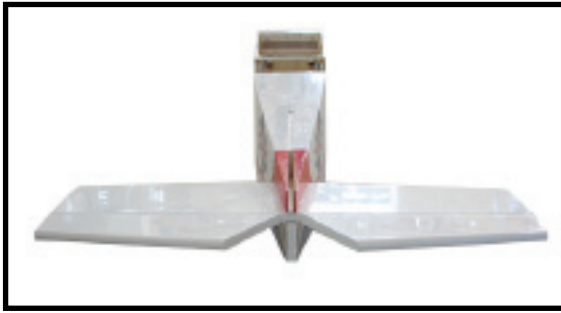

INSTALLING VERTICAL FIN.



1) Using a modeling knife, remove the covering from over the precut hinge slot cut into the lower rear portion of the fuselage.

2) Slide the vertical stabilizer into the slot in the top of the fuselage. The rear edge of the stabilizer should be flush with the rear edge of the fuselage and the lower rudder hinge should engage the precut hinge slot in the lower fuselage. The bottom edge of the stabilizer should also be firmly pushed against the top of the horizontal stabilizer.



3) While holding the vertical stabilizer firmly in place, use a pen and draw a line on each side of the vertical stabilizer where it meets the top of the fuselage.

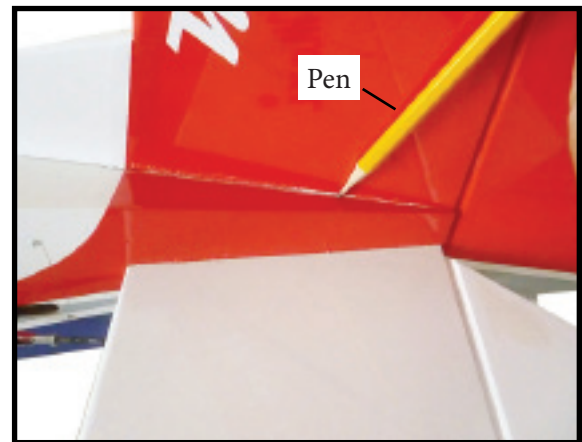

4) Remove the stabilizer. Using a modeling knife, remove the covering from below the lines you drew.

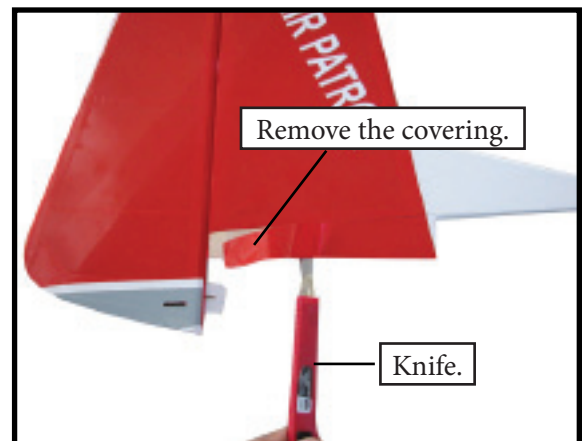

! *When cutting through the covering to remove it, cut with only enough pressure to only cut through the covering itself. Cutting into the balsa structure may weaken it.*

5) Slide the vertical stabilizer back in place. Using a triangle, check to ensure that the vertical stabilizer is aligned 90° to the horizontal stabilizer.

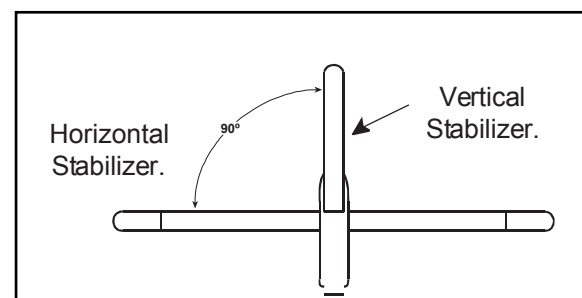

6) When you are sure that everything is aligned correctly, mix up a generous amount of Flash 30 Minute Epoxy. Apply a thin layer to the mounting slot and to bottom of the vertical stabilizer mounting area. Apply epoxy to the bottom and top edges of the filler block and to the lower hinge also. Set the stabilizer in place and realign. Double check all of your measurements once more before the epoxy cures. Hold the stabilizer in place with T-pins or masking tape and remove any excess epoxy using a paper towel and rubbing alcohol. Allow the epoxy to fully cure before proceeding.

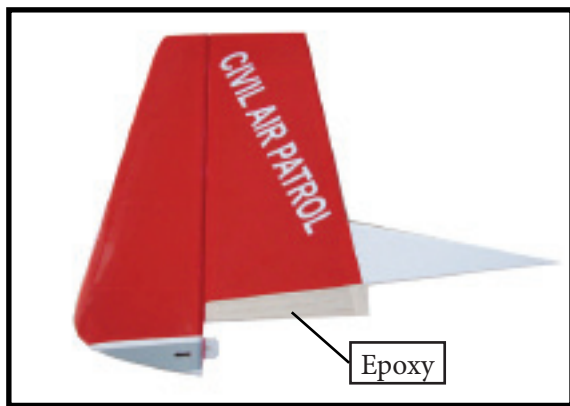

ELEVATOR PUSHROD INSTALLATION.

- 1) Install the elevator control horn using the same method as with the aileron control horns.
- 2) Position the elevator control horn on the both side of elevator.

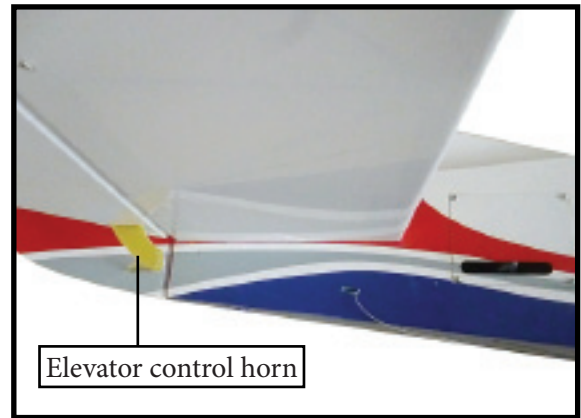

3) Thread one clevis and M2 lock nut on to each elevator control rod. Thread the horns on until they are flush with the ends of the control rods.

4) Elevator and rudder pushrods assembly as pictures below.

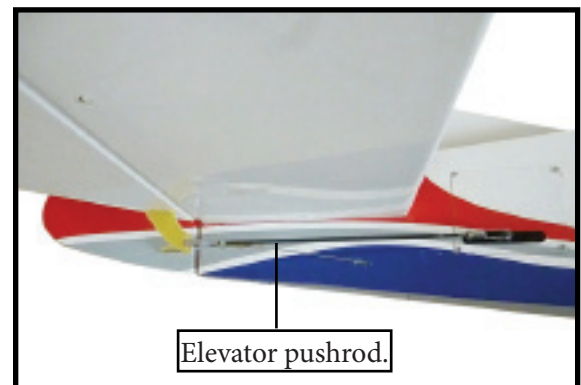
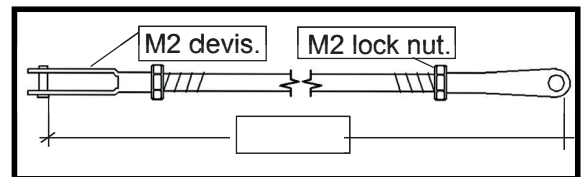
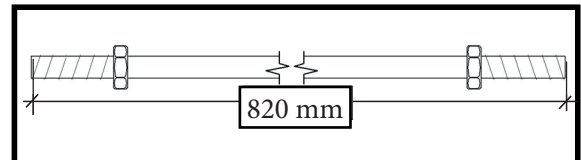

RUDDER PUSHROD INSTALLATION.

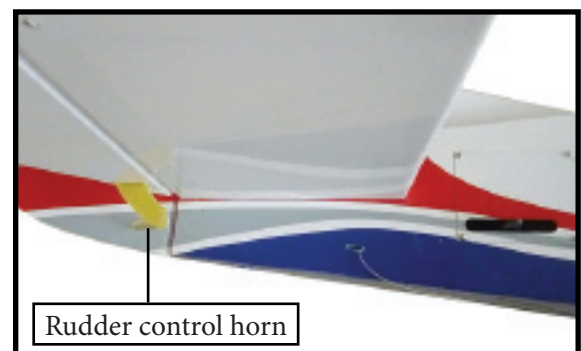

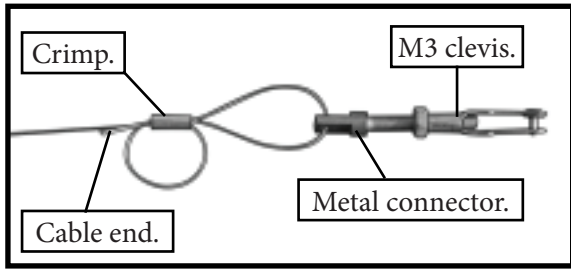

THE TAIL WHEEL - STRUT SUPPORT.

Locate items necessary to install tail wheel.

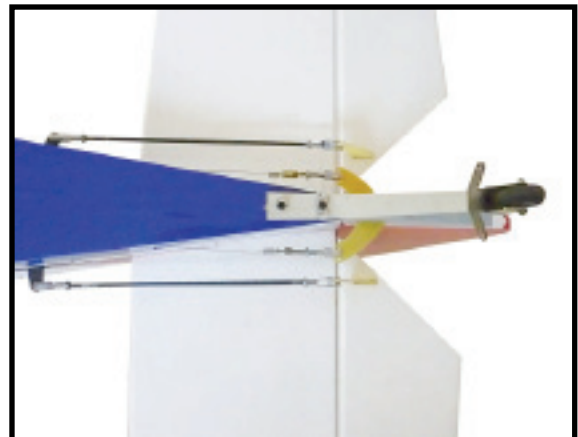
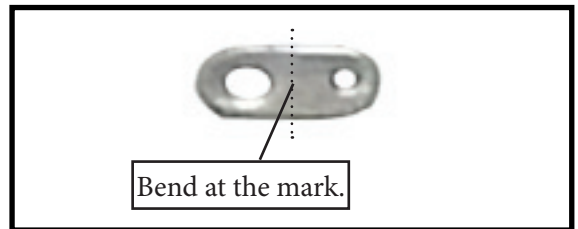
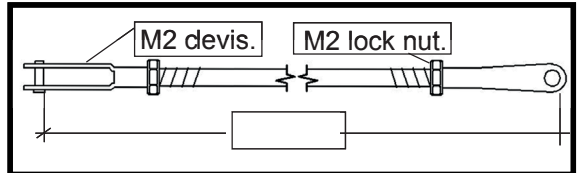
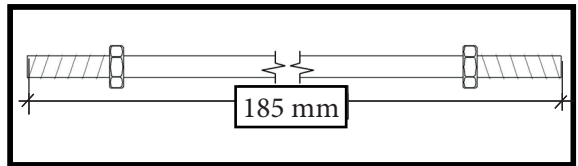
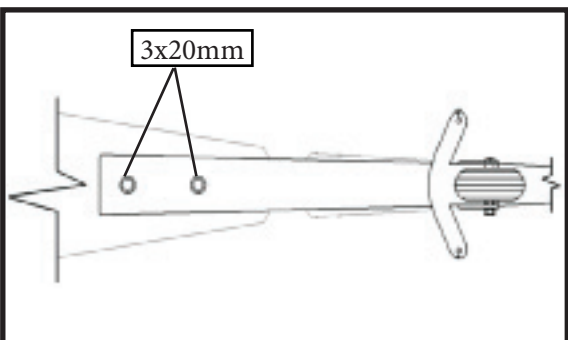
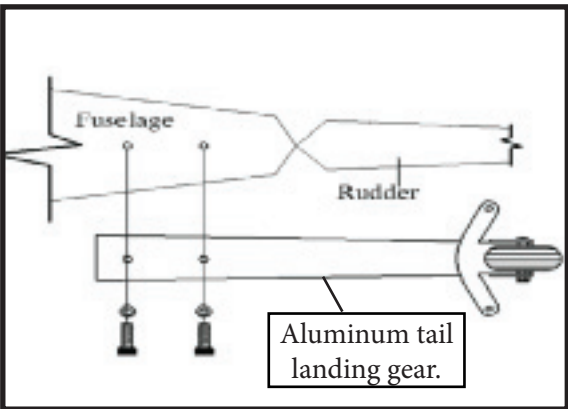

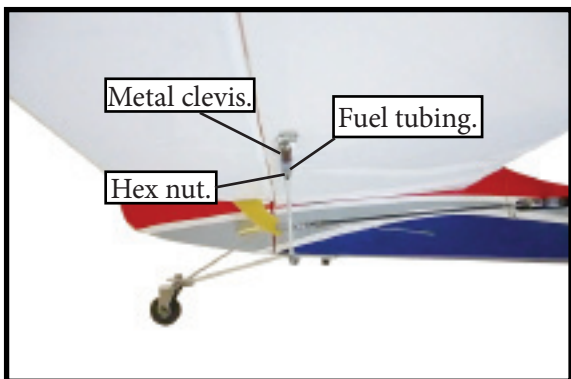
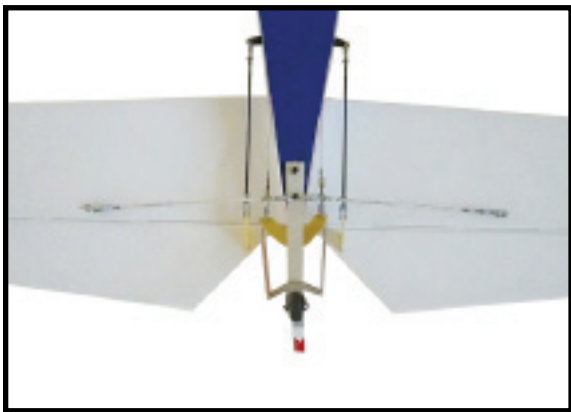
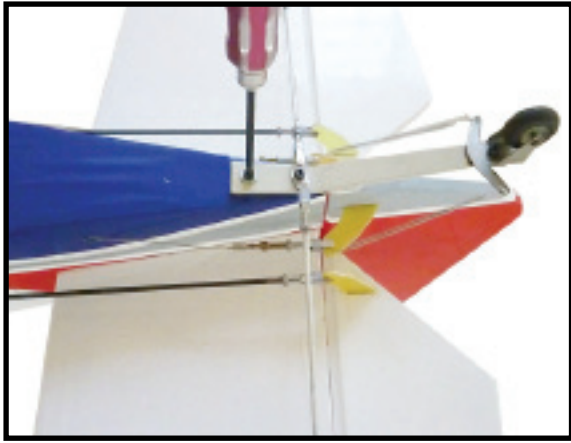

INSTALLING TAIL STRUT SUPPORT.

The tail strut system assembly follow pictures below.

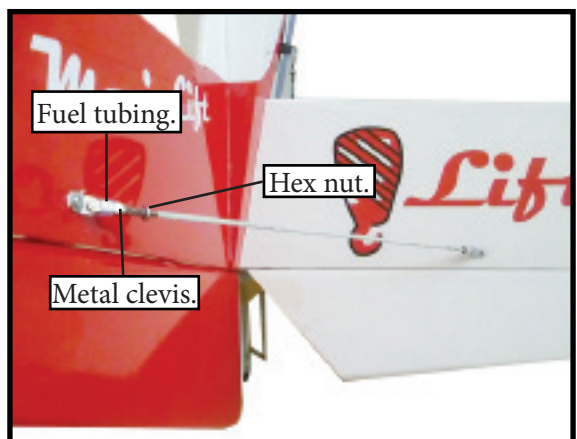
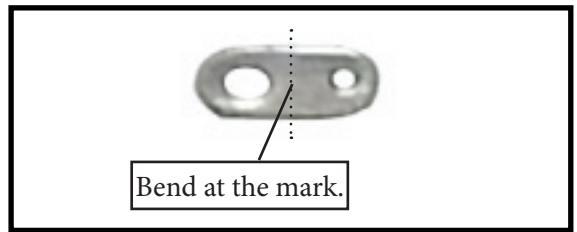
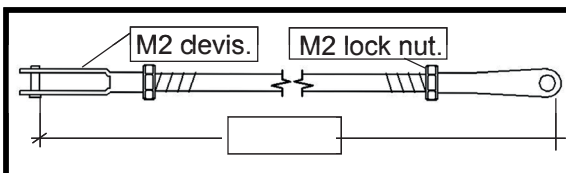
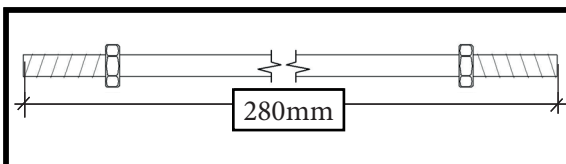

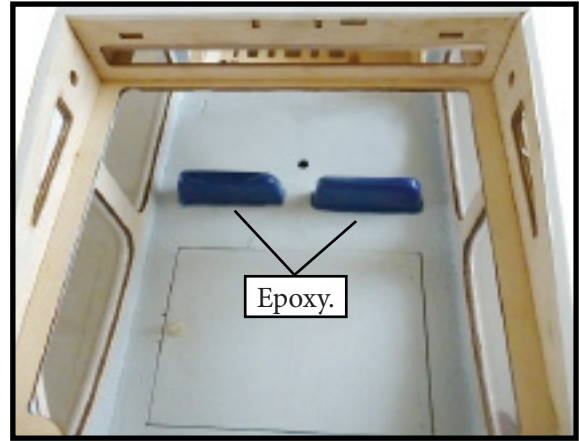

INSTALLATION PILOT AND CANOPY.

1) Locate items necessary to install pilot and canopy.

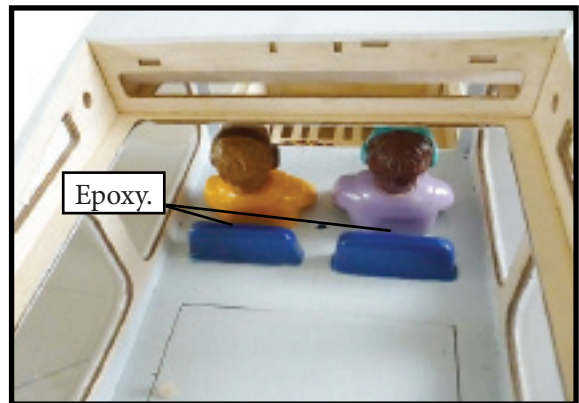

2) A scale pilot is included with this ARF. The Pilot included fitting well to the cockpit. (or you can order others scale pilot figures made by SG-Models.They are available at SG-Models distributors.)

If you are going to install a pilot figure, please use a sanding bar to sand the base of the figure so that it is flat.

3) Position the pilot figure on the canopy floor as show. Locate the oval shaped on the canopy floor and remove the covering. Use epoxy to glue this into the base of the pilot figure and glue the cockpit panel in place with C/A glue, please see pictures as shown.



4) Position the canopy onto the fuselage. Trace around the canopy and onto the fuselage using a felt-tipped pen.



APPLY THE DECALS.

- 1) If all the decals are precut and ready to stick. Please be certain the model is clean and free from oily fingerprints and dust. Position decal on the model where desired, using the photos on the box and aid in their location.
- 2) If all the decals are not precut, please use scissors or a sharp hobby knife to cut the decals from the sheet. Please be certain the model is clean and free from oily fingerprints and dust. Position decal on the model where desired, using the photos on the box and aid in their location.

INSTALLING THE BATTERY-RECEIVER.

- 1) Plug the five servo leads and the switch lead into the receiver. Plug the battery pack lead into the switch also.
- 2) Wrap the receiver and battery pack in the protective foam rubber to protect them from vibration.
- 3) Route the antenna in the antenna tube inside the fuselage and secure it to the bottom of fuselage using a plastic tape.

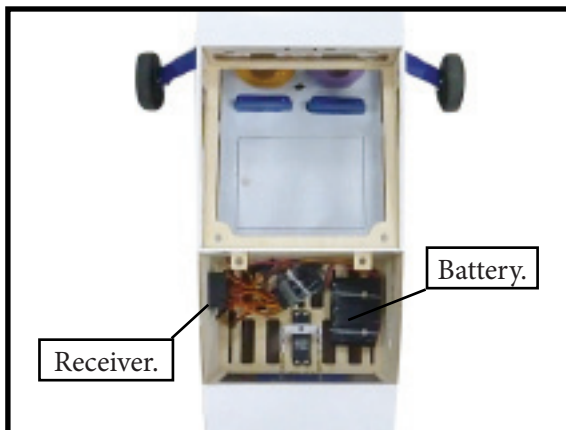

ATTACHMENT WING-FUSELAGE.

Attach the aluminium tube into fuselage.

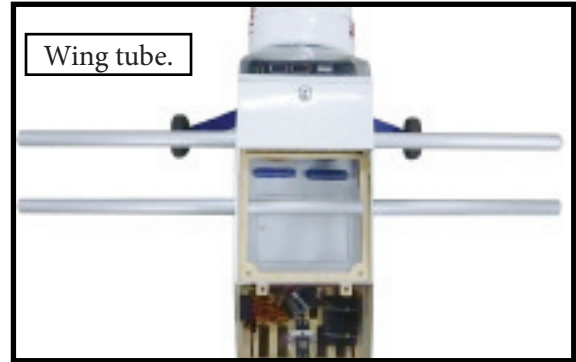

Insert two wing panels as pictures below.

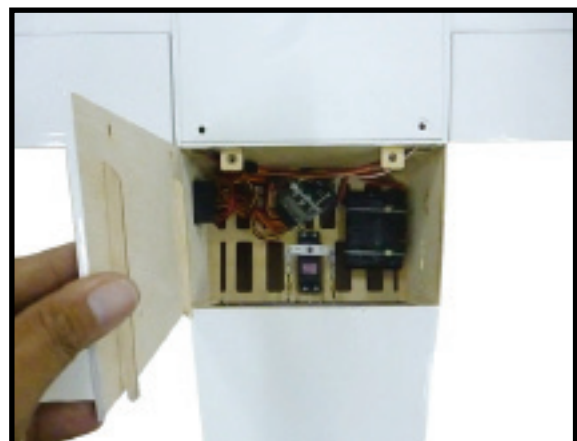
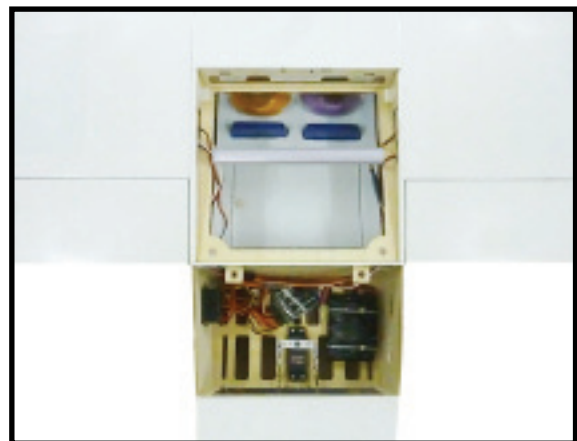
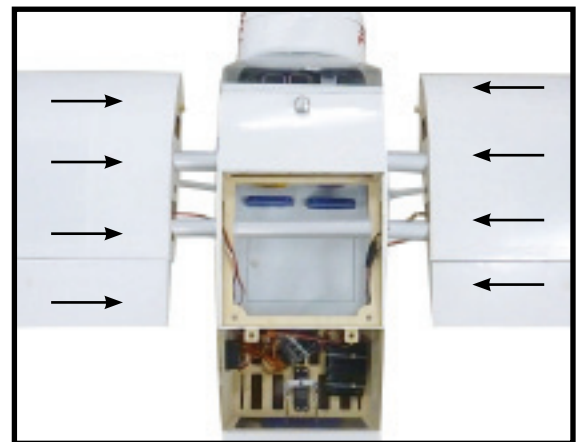

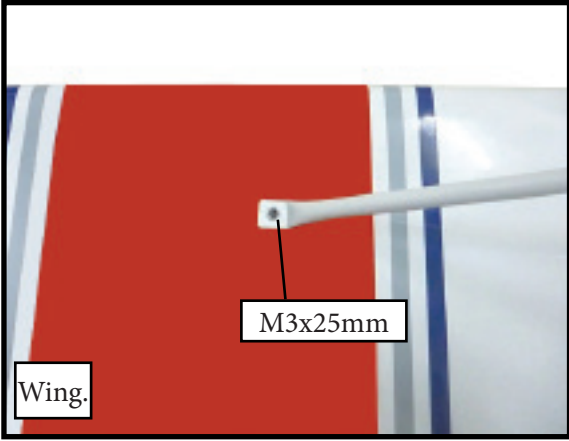
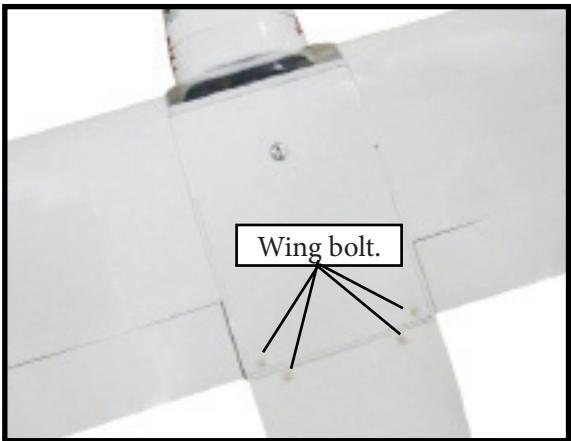

INSTALLATION WING- FUSELAGE STRUTS.

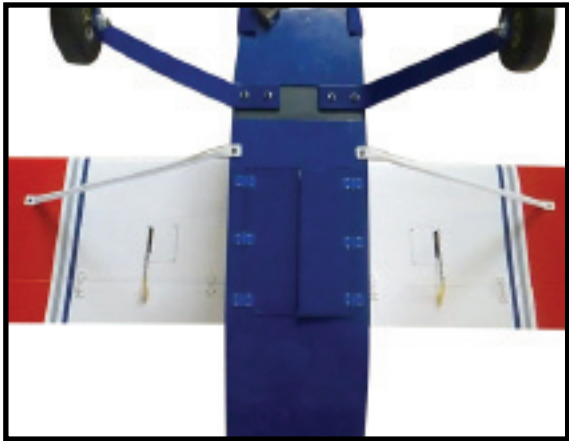
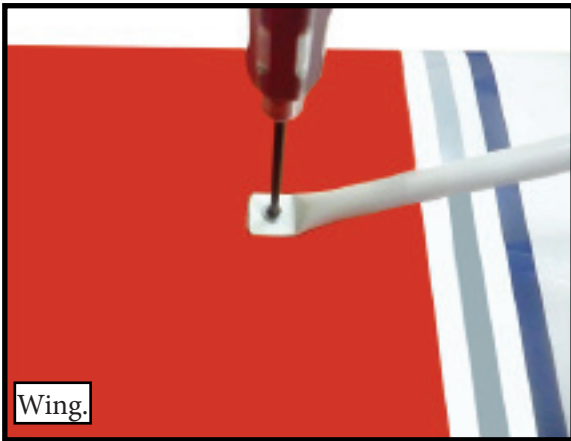
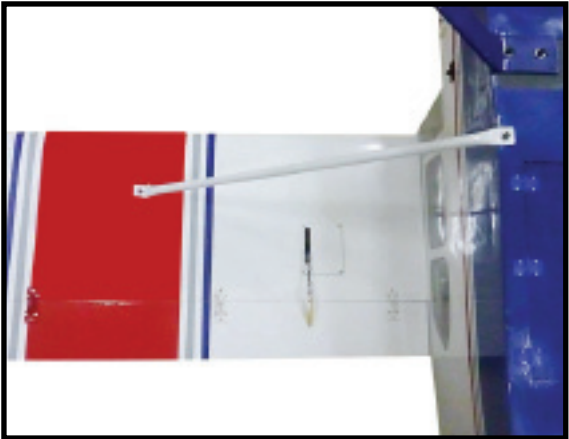
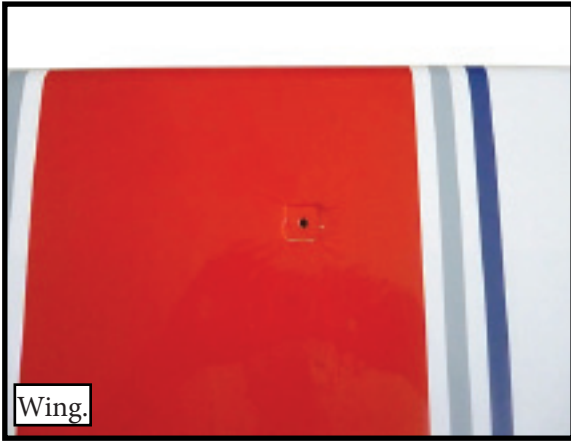
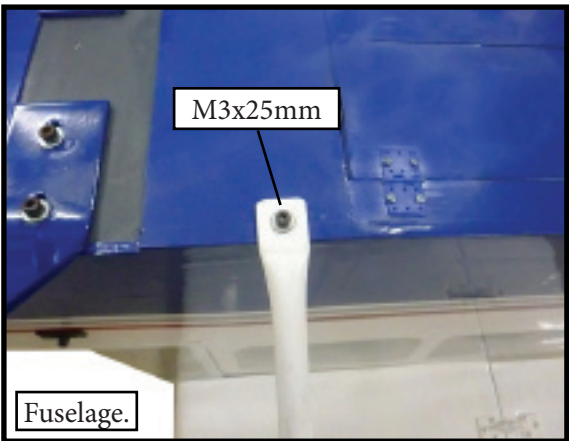
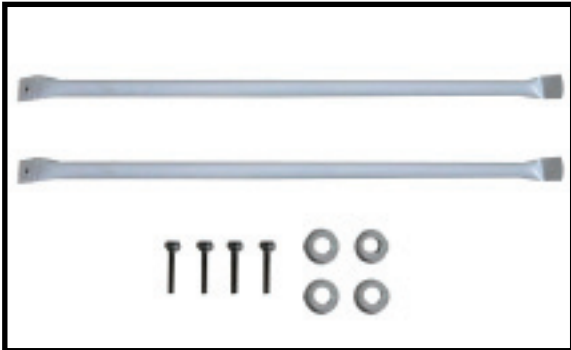



BALANCING.

1) It is critical that your airplane be balanced correctly. Improper balance will cause your plane to lose control and crash. THE CENTER OF GRAVITY IS LOCATED **110 MM** BACK FROM THE LEADING EDGE OF THE WING AT THE WING ROOT.

2) Mount the wing to the fuselage. Using a couple of pieces of masking tape, place them on the top side of the wing **110 mm** back from the leading edge of the wing at the wing root.

3) Turn the airplane upside down. Place your fingers on the masking tape and carefully lift the plane .

Accurately mark the balance point on the top of the wing on both sides of the fuselage. The balance point is located **110 mm** back from the leading edge of the wing at the wing root. This is the balance point at which your model should balance for your first flights. Later, you may wish to experiment by shifting the balance up to 10mm forward or back to change the flying characteristics. Moving the balance forward may improve the smoothness and arrow- like tracking, but it may then require more speed for take off and make it more difficult to slow down for landing. Moving the balance aft makes the model more agile with a lighter and snappier "feel". In any case, please start at the location we recommend .

With the wing attached to the fuselage, all parts of the model installed (ready to fly), and empty fuel tanks, hold the model at the marked balance point with the stabilizer level.

Lift the model. If the tail drops when you lift, the model is "tail heavy" and you must add weight* to the nose. If the nose drops, it is "nose heavy" and you must add weight* to the tail to balance.

*If possible, first attempt to balance the model by changing the position of the receiver battery and receiver. If you are unable to obtain good balance by doing so, then it will be necessary to add weight to the nose or tail to achieve the proper balance point.

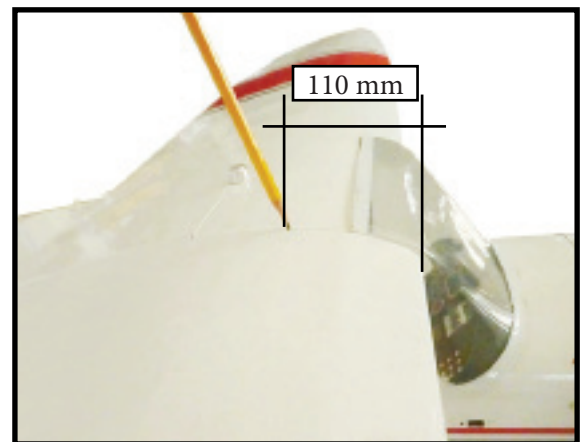

CONTROL THROWS.

Ailerons:	12mm - 15mm up 12mm - 15mm down.
Elevator:	12mm - 15mm up. 12mm - 15mm down.
Rudder:	20mm - 30mm left. 20mm - 30mm right

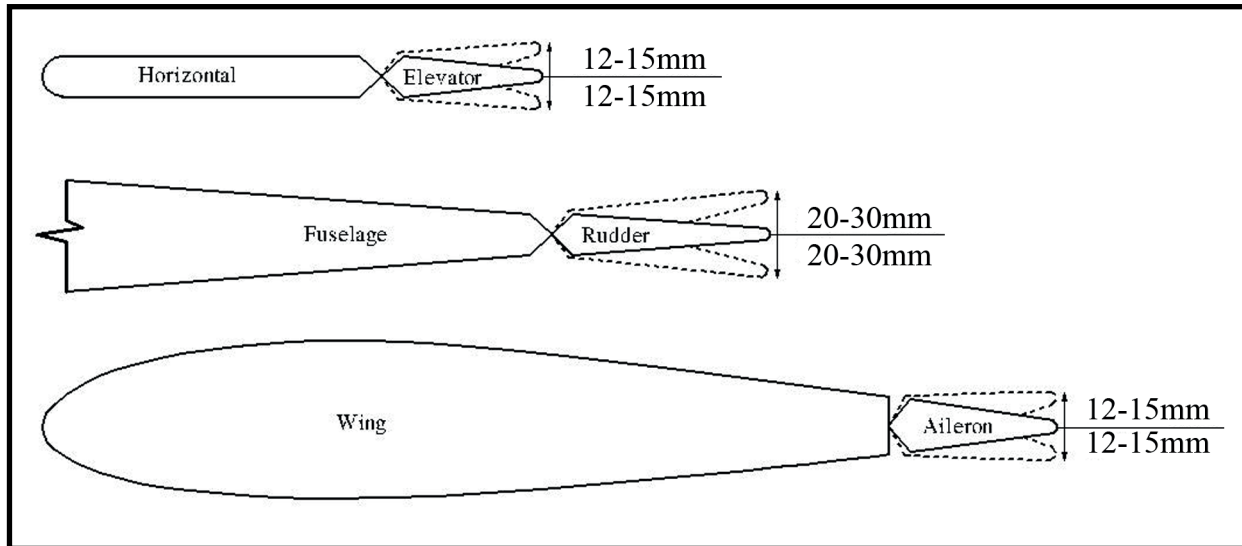

FLIGHT PREPARATION.

Check the operation and direction of the elevator, rudder, ailerons and throttle.

- A) Plug in your radio system per the manufacturer's instructions and turn everything on.
- B) Check the elevator first. Pull back on the elevator stick. The elevator halves should move up. If they do not, flip the servo reversing switch on your transmitter to change the direction.
- C) Check the rudder. Looking from behind the airplane, move the rudder stick to the right. The rudder should move to the right. If it does not, flip the servo reversing switch on your transmitter to change the direction.
- D) Check the throttle. Moving the throttle stick forward should open the carburetor barrel. If it does not, flip the servo reversing switch on your transmitter to change the direction.
- E) From behind the airplane, look at the aileron on the right wing half. Move the aileron stick to the right. The right aileron should move up and the other aileron should move down. If it does not, flip the servo reversing switch on your transmitter to change the direction.

PREFLIGHT CHECK.

- 1) Completely charge your transmitter and receiver batteries before your first day of flying.
- 2) Check every bolt and every glue joint in the **MAXI LIFT** to ensure that everything is tight and well bonded.
- 3) Double check the balance of the airplane. Do this with the fuel tank empty.
- 4) Check the control surfaces. All should move in the correct direction and not bind in any way.
- 5) If your radio transmitter is equipped with dual rate switches double check that they are on the low rate setting for your first few flights.
- 6) Check to ensure the control surfaces are moving the proper amount for both low and high rate settings.
- 7) Check the receiver antenna. It should be fully extended and not coiled up inside the fuselage.
- 8) Properly balance the propeller. An out of balance propeller will cause excessive vibration which could lead to engine and/or airframe failure.

*We wish you many safe and enjoyable flights
with your MAXI LIFT.*